

FUJI Power Semiconductors

Power MOSFETs Selection Guide

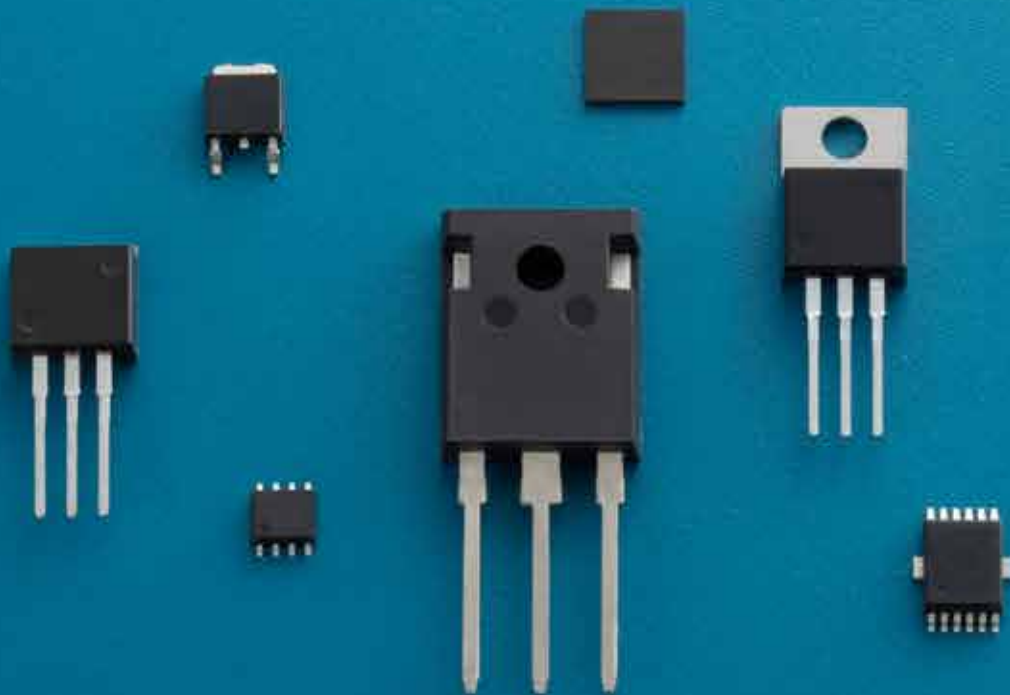

CONTENTS

Super J MOS [®] S2 Series	6
Super J MOS [®] S2FD Series	7
SuperFAP-E ³ Series	8
SuperFAP-E ^{3S} Series	9
SuperFAP-G Series	10
SuperFAP-G Built-in FRED Series	12
Trench Power MOSFET Series	12
Automotive Super J MOS [®] S2 Series	13
Automotive Super J MOS [®] S2FD Series	14
Automotive SuperFAP-E ^{3S} Series	14
Automotive Trench Power MOS Series	15
Automotive IPS Series (Intelligent Power Switches)	16

Super J MOS[®] is registered trademarks of Fuji Electric.

Super J MOS[®] S2 Series

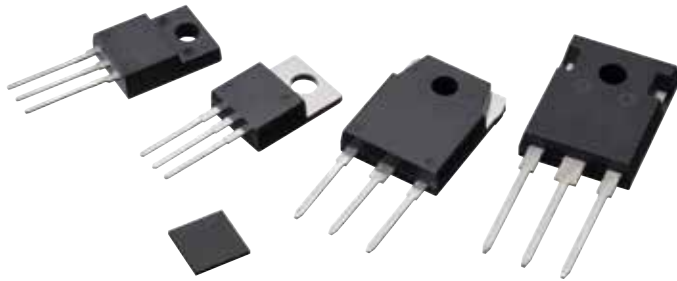

■ Concept

By improving the impurity profile of the super junction structure, Super J MOS[®] S2 has significantly improved the trade-off between device breakdown voltage and on-resistance ($R_{on} \cdot A$) compared to the previous product (Super J MOS[®] S1 Series). In addition, by reducing the trade-off between turn-off loss and turn-off dv/dt , Super J MOS[®] S2 has been able to achieve lower loss and noise characteristics, thereby contributing to high efficiency and miniaturization of power supplies.

■ Features & Benefit of Super J MOS[®] S2 series

Feature	Benefit
Low on-state resistance Low switching loss	→ High efficiency High power density
Low gate charge (Q_G) Low energy stored in output capacitance (E_{OSS})	→ High efficiency at low load
Easy to use (more controllable dv/dt by R_G and Low V_{DS} surge)	→ Easy to design
100% avalanche tested	→ High reliability

■ Applications

PFC or PWM converter for Server, PC, PCS, UPS, LCD-TV, Lighting and Standard power supply

Super J MOS[®] is registered trademarks of Fuji Electric.
FRED: Fast Recovery Epitaxial Diode.

Super J MOS[®] S2FD Series (Built-in FRED type)

■ Features

- t_{rr} of S2FD is 50% faster than S2
- High diode recovery ruggedness (High $-di_{DR}/dt$ ruggedness)
- 100% avalanche tested

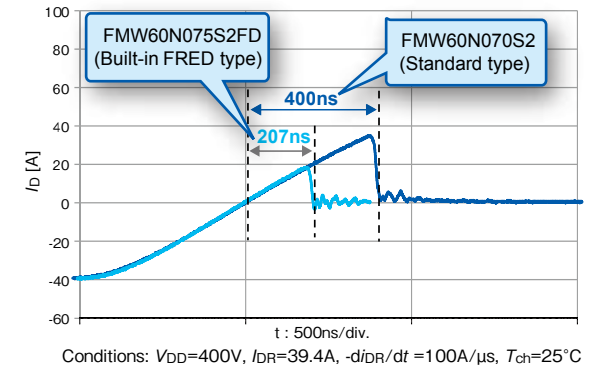

PFC stage Efficiency difference

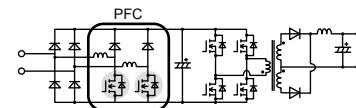
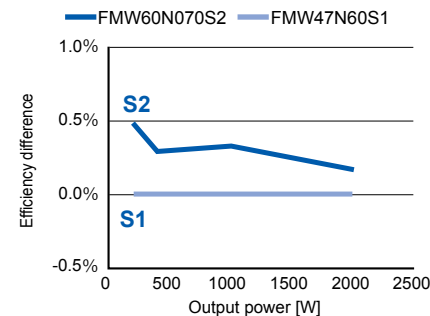

Circuit : PFC+LLC(Exchanged PFC MOS)
Input : 230V AC 50Hz
Output:53.5V/Iout=37A
External R_G : 2 Ω
Sample : 600V/70m Ω max.

LLC stage Efficiency difference

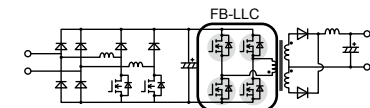
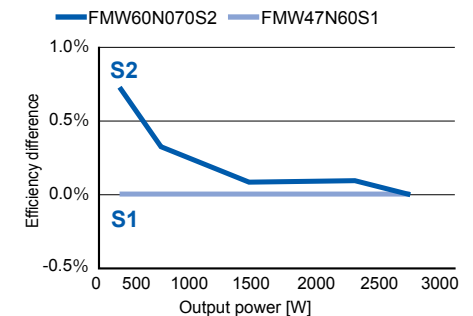

Circuit : PFC+LLC(Exchanged LLC MOS)
Input : 230V AC 50Hz
Output : 49V/Iout=6.12~56.01A
External R_G : 5.1 Ω
Sample : 600V/70m Ω max.

■ Applications

For resonant switching topologies in applications like UPS, Server, Telecom, LED lighting, Power conditioner system and Power supply.

SuperFAP-E³, E^{3S} Series

■ Concept

The second generation Quasi-Planer Junction technology copes with both low loss/noise and usability.

And this technology lets us achieve high performance for power supply's circuit design.

■ Features

- Coping with both low loss and low noise
- Low $R_{DS(on)}$
- High controllability of gate resistance during switching
- Low V_{GS} ringing waveform during switching
- Narrow band of the gate threshold voltage ($3.0 \pm 0.5V$)
- High avalanche durability
- SuperFAP-E^{3S} is Low Q_G type of SuperFAP-E³

Concept

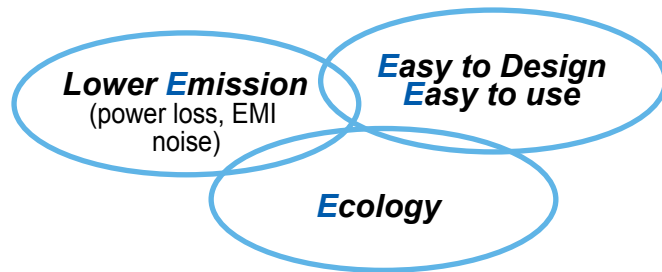

SuperFAP-G Series

■ Concept

The Quasi-Planer Junction technology achieves low $R_{DS(on)}$ and low switching loss (low Q_{GD}).

■ Features

- Low turn off loss
- Low Gate charge
- High avalanche durability
- Low $R_{DS(on)}$



No.	Products Category	Page	Built-in FRED Type	V _{bss}					Rated Current				
				≤80V	>80V ≤250V	>250V ≤500V	>500V ≤650V	>650V ≤900V	≤5A	>5A ≤10A	>10A ≤30A	>30A ≤50A	>50A ≤100A
1	Super J MOS [®] S2 Series	6					✓			✓	✓	✓	✓
2	Super J MOS [®] S2FD Series	7	✓				✓				✓	✓	✓
3	SuperFAP-E ³ Series	8				✓	✓	✓	✓	✓	✓		
4	SuperFAP-E ^{3S} Series	9				✓	✓			✓	✓		
5	SuperFAP-G Series	10		✓	✓	✓	✓	✓	✓	✓	✓	✓	✓
6	SuperFAP-G Built-in FRED Series	12	✓			✓	✓				✓	✓	
7	Trench Power MOSFET Series	12		✓	✓							✓	✓
8	Automotive Super J MOS [®] S2 Series	13					✓				✓	✓	✓
9	Automotive Super J MOS [®] S2FD Series	14	✓			✓	✓				✓	✓	
10	Automotive SuperFAP-E ^{3S} Series	14	✓			✓	✓				✓	✓	✓
11	Automotive Trench Power MOS Series	15		✓	✓								✓
12	Automotive IPS Series (Intelligent Power Switches)	16		✓					✓	✓	✓		✓

Part numbers

FMV60N190S2 (example)

F	M	V	60	N	190	S2				
Company Symbol	Device code		Package code	Voltage	Polarity	Ron (mΩ)	Series			
Fuji	M	MOSFET	C	T-Pack(S)	× 1/10	N	N-ch	× 1	S2	Super J MOS [®] 2nd Gen.
			H	TO-3P(Q)					S2FD	Super J MOS [®] 2nd Gen.(FRED)
			L	DFN8x8					S2A	Super J MOS [®] 2nd Gen.for Automotive
			P	TO-220					S2FDA	Super J MOS [®] 2nd Gen.(FRED) for Automotive
			V	TO-220F(SLS)						
			W	TO-247(Type:B)						
			Y	TO-247(Type:A)						

FMV20N50ES (example)

F	M	V	20	N	50	ES				
Company Symbol	Device code		Package code	Current	Polarity	Voltage	Series			
Fuji	M	MOSFET	A	TO-220F	× 1	N	N-ch	× 1/10	E	SuperFAP-E ³
			C	T-Pack(S)					ES	SuperFAP-E ^{3S}
			H	TO-3P(Q)					G	SuperFAP-G
			I	T-Pack(L)					T2	Trench
			L	TFP					R	3G-Trench
			P	TO-220						
			R	TO-3PF						
			V	TO-220F(SLS)						
			W	TO-247(Type:B)						
			Y	TO-247(Type:A)						

Super J MOS[®] is registered trademarks of Fuji Electric.

Product Map

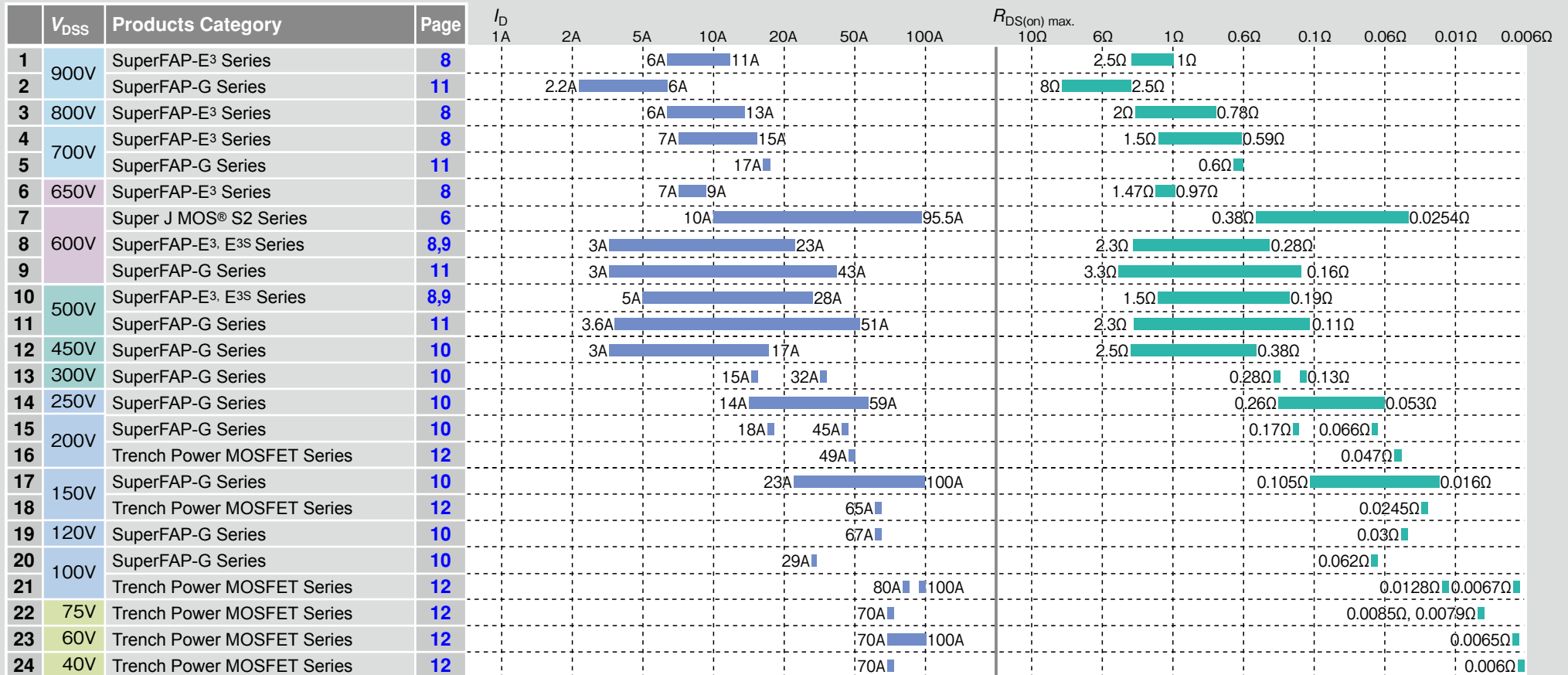

Built-in FRED Type

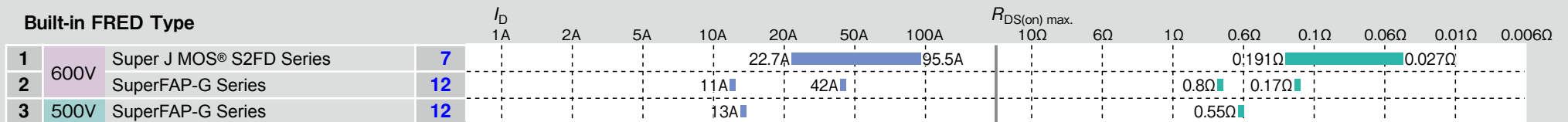

Product Map (Automotive)

V _{DSS}	Products Category	Page	I _D							R _{DS(on) max.}									
			1A	2A	5A	10A	20A	50A	100A	10Ω	1Ω	0.6Ω	0.1Ω	0.06Ω	0.01Ω	0.006Ω	0.001Ω		
600V	Automotive Super J MOS® S2 Series	13					15.5A		95.5A					0.19Ω		0.025Ω			
	Automotive SuperFAP-E ^{3S} Series	14					24A	36A						0.28Ω	0.16Ω				
300V	Automotive SuperFAP-E ^{3S} Series	14						50A	72A					0.072Ω	0.045Ω				
100V	Automotive Trench MOSFET	15							80A	100A						0.0067Ω			
75V	Automotive Trench MOSFET	15							70A							0.0085Ω	0.0079Ω		
60V	Automotive Trench MOSFET	15							70A	100A						0.0065Ω			
40V	Automotive Trench MOSFET	15							70A							0.006Ω			

Built-in FRED Type

V _{DSS}	Products Category	Page	I _D							R _{DS(on) max.}								
			1A	2A	5A	10A	20A	50A	100A	10Ω	1Ω	0.6Ω	0.1Ω	0.06Ω	0.01Ω	0.006Ω	0.001Ω	
600V	Automotive Super J MOS® S2FD Series	14					22.8A	37.0A						0.133Ω	0.080Ω			
	Automotive SuperFAP-E ^{3S} Series	14					22A	35A						0.29Ω	0.17Ω			
500V	Automotive Super J MOS® S2FD Series	14					38.9A							0.071Ω				
400V	Automotive Super J MOS® S2FD Series	14					42A							0.06Ω				
300V	Automotive SuperFAP-E ^{3S} Series	14					47A	67A						0.085Ω	0.053Ω			

IPS (Intelligent Power Switches)

V _{DSS}	Products Category	Page	I _D							R _{DS(on) max.}								
			1A	2A	5A	10A	20A	50A	100A	10Ω	1Ω	0.6Ω	0.1Ω	0.06Ω	0.01Ω	0.006Ω	0.001Ω	
35V	Automotive IPS Series (High Side 1ch)	16		2A					80A					0.12Ω				0.005Ω
	Automotive IPS Series (High Side 2ch)	16		1.6A										0.12Ω				
40V	Automotive IPS Series (Low Side 1ch)	16			3A	8A	12A							0.4Ω	0.14Ω			
	Automotive IPS Series (Low Side 2ch)	16	1A	1.9A	5.9A									0.6Ω	0.14Ω			

■ Super J MOS[®] S2 series

Super J MOS [®] S2 series			TO-220	TO-220F(SLS)	TO-3P(Q)	TO-247(Type:B)
						
V_{DSS} (V)	$R_{DS(on)}$ max.(Ω)	I_D (A)				
600	0.380	10	FMP60N380S2	FMV60N380S2		
	0.280	13	FMP60N280S2	FMV60N280S2	FMH60N280S2	
	0.190	20	FMP60N190S2	FMV60N190S2	FMH60N190S2	FMW60N190S2
	0.160	23.9	FMP60N160S2	FMV60N160S2		FMW60N160S2
	0.125	30.1	FMP60N125S2	FMV60N125S2		FMW60N125S2
	0.099	38.1	FMP60N099S2	FMV60N099S2		FMW60N099S2
	0.088	42.3	FMP60N088S2	FMV60N088S2		FMW60N088S2
	0.079	47.9	FMP60N079S2	FMV60N079S2		FMW60N079S2
	0.070	53.2		FMV60N070S2		FMW60N070S2
	0.055	64.4				FMW60N055S2
	0.040	77.5				FMW60N040S2
0.0254	95.5				FMW60N025S2	







The Super J MOS[®] series products satisfy the quality assurance level of general consumer use.
 If you intend to use the products for equipment requiring higher reliability, such as equipment for automobiles and medical equipment, please contact Fuji Electric.
 Do not use the products for equipment requiring strict reliability such as aerospace equipment.

■ Super J MOS[®] S2FD series (Built-in FRED Type)

Super J MOS [®] S2FD series (Built-in FRED Type)			TO-220	TO-220F(SLS)	TO-247(Type:B)	DFN8×8
V_{DSS} (V)	$R_{DS(on)}$ max.(Ω)	I_D (A)				
600	0.191	22.7				FML60N191S2FD
	0.170	23.9	FMP60N170S2FD	FMV60N170S2FD	FMW60N170S2FD	
	0.150	28.7				FML60N150S2FD
	0.133	30.1	FMP60N133S2FD	FMV60N133S2FD	FMW60N133S2FD	
	0.118	37.1				FML60N118S2FD
	0.105	38.1	FMP60N105S2FD	FMV60N105S2FD	FMW60N105S2FD	
	0.104	41.3				FML60N104S2FD
	0.094	42.3	FMP60N094S2FD	FMV60N094S2FD	FMW60N094S2FD	
	0.093	42.3				FML60N093S2FD
	0.084	47.9	FMP60N084S2FD	FMV60N084S2FD	FMW60N084S2FD	
	0.075	53.2		FMV60N075S2FD	FMW60N075S2FD	
	0.059	64.4			FMW60N059S2FD	
	0.043	77.5			FMW60N043S2FD	
0.027	95.5			FMW60N027S2FD		







The Super J MOS[®] series products satisfy the quality assurance level of general consumer use.
 If you intend to use the products for equipment requiring higher reliability, such as equipment for automobiles and medical equipment, please contact Fuji Electric.
 Do not use the products for equipment requiring strict reliability such as aerospace equipment.

■ SuperFAP-E³ series

SuperFAP-E ³ series			TO-220	TO-220F(SLS)	TO-3P(Q)	TO-3PF	T-Pack(L)	T-Pack(S)
V_{DSS} (V)	$R_{DS(on)}$ max.(Ω)	I_D (A)						
500	1.5	5	FMP05N50E	FMV05N50E			FMI05N50E	FMC05N50E
	0.85	6.5	FMP07N50E	FMV07N50E			FMI07N50E	FMC07N50E
	0.79	7.5	FMP08N50E	FMV08N50E				
	0.52	12	FMP12N50E	FMV12N50E			FMI12N50E	FMC12N50E
	0.38	16	FMP16N50E	FMV16N50E	FMH16N50E		FMI16N50E	FMC16N50E
	0.31	20	FMP20N50E	FMV20N50E	FMH20N50E		FMI20N50E	FMC20N50E
	0.245	23		FMV23N50E	FMH23N50E	FMR23N50E		
	0.19	28			FMH28N50E	FMR28N50E		
600	2.3	3	FMP03N60E	FMV03N60E			FMI03N60E	FMC03N60E
	1.3	5.5	FMP05N60E	FMV05N60E			FMI05N60E	FMC05N60E
	1.2	6	FMP06N60E	FMV06N60E				
	0.79	10	FMP10N60E	FMV10N60E			FMI10N60E	FMC10N60E
	0.75	11	FMP11N60E	FMV11N60E			FMI11N60E	FMC11N60E
	0.58	13	FMP13N60E	FMV13N60E			FMI13N60E	FMC13N60E
	0.47	16	FMP16N60E	FMV16N60E			FMI16N60E	FMC16N60E
	0.365	19		FMV19N60E	FMH19N60E	FMR19N60E		
	0.28	23			FMH23N60E	FMR23N60E		
650	1.47	7		FMV07N65E				
	0.97	9		FMV09N65E				
700	1.5	7		FMV07N70E	FMH07N70E			
	1.2	9		FMV09N70E	FMH09N70E			
	0.85	11		FMV11N70E	FMH11N70E			
	0.59	15		FMV15N70E				
800	2	6		FMV06N80E	FMH06N80E		FMI06N80E	FMC06N80E
	1.6	8		FMV08N80E	FMH08N80E		FMI08N80E	FMC08N80E
	1.1	10		FMV10N80E	FMH10N80E			
	0.78	13		FMV13N80E	FMH13N80E			
900	2.5	6		FMV06N90E	FMH06N90E		FMI06N90E	FMC06N90E
	2	7		FMV07N90E	FMH07N90E		FMI07N90E	FMC07N90E
	1.4	9		FMV09N90E	FMH09N90E	FMR09N90E		
	1	11		FMV11N90E	FMH11N90E	FMR11N90E		









The SuperFAP-E³ series products satisfy the quality assurance level of general consumer use. If you intend to use the products for equipment requiring higher reliability, such as equipment for automobiles and medical equipment, please contact Fuji Electric. Do not use the products for equipment requiring strict reliability such as aerospace equipment.

■ SuperFAP-E^{3S} series

SuperFAP-E ^{3S} series			TO-220	TO-220F(SLS)	TO-3P(Q)	TO-3PF	T-Pack(L)	T-Pack(S)	TFP
V_{DS} (V)	$R_{DS(on)}$ max. (Ω)	I_D (A)							
500	0.5	12	FMP12N50ES	FMV12N50ES			FMI12N50ES	FMC12N50ES	FML12N50ES
	0.38	16	FMP16N50ES	FMV16N50ES	FMH16N50ES		FMI16N50ES	FMC16N50ES	FML16N50ES
	0.31	20	FMP20N50ES	FMV20N50ES	FMH20N50ES		FMI20N50ES	FMC20N50ES	FML20N50ES
	0.27	21		FMV21N50ES	FMH21N50ES	FMR21N50ES			
	0.245	23		FMV23N50ES	FMH23N50ES	FMR23N50ES			
	0.19	28			FMH28N50ES	FMR28N50ES			
600	1.2	6	FMP06N60ES	FMV06N60ES			FMI06N60ES	FMC06N60ES	
	0.75	12	FMP12N60ES	FMV12N60ES			FMI12N60ES	FMC12N60ES	FML12N60ES
	0.58	13	FMP13N60ES	FMV13N60ES	FMH13N60ES		FMI13N60ES	FMC13N60ES	FML13N60ES
	0.47	16	FMP16N60ES	FMV16N60ES	FMH16N60ES		FMI16N60ES	FMC16N60ES	FML16N60ES
	0.4	17		FMV17N60ES	FMH17N60ES	FMR17N60ES			
	0.365	19		FMV19N60ES	FMH19N60ES	FMR19N60ES			
	0.28	23			FMH23N60ES	FMR23N60ES			

The SuperFAP-E^{3S} series products satisfy the quality assurance level of general consumer use. If you intend to use the products for equipment requiring higher reliability, such as equipment for automobiles and medical equipment, please contact Fuji Electric. Do not use the products for equipment requiring strict reliability such as aerospace equipment.







■ SuperFAP-G series

SuperFAP-G series			TO-220	TO-220F	TO-220F(SLS)	TO-3PF	TO-247(Type:A)	T-Pack(L)	T-Pack(S)	TFP
V_{DSS} (V)	$R_{DS(on)}$ max. (Ω)	I_D (A)								
100	0.062	29	2SK3598-01	2SK3599-01MR				2SK3600-01L	2SK3600-01S	
120	0.03	67	2SK3920-01	2SK3886-01MR				2SK3921-01L	2SK3921-01S	2SK3922-01
150	0.105	23	2SK3602-01	2SK3603-01MR				2SK3604-01L	2SK3604-01S	
	0.07	33	2SK3648-01	2SK3649-01MR 2SK3537-01MR*1				2SK3650-01L	2SK3650-01S	2SK3474-01
	0.041	57	2SK3590-01	2SK3591-01MR				2SK3592-01L	2SK3592-01S	2SK3593-01
	0.016	100					2SK3882-01			
200	0.17	18	2SK3606-01	2SK3607-01MR				2SK3608-01L	2SK3608-01S	2SK3609-01
	0.066	45	2SK3594-01	2SK3595-01MR				2SK3596-01L	2SK3596-01S	2SK3597-01
250	0.26	14	2SK3610-01	2SK3611-01MR				2SK3612-01L	2SK3612-01S	
	0.13	24			FMV24N25G					
	0.1	37	2SK3554-01	2SK3555-01MR		2SK3651-01R		2SK3556-01L	2SK3556-01S	2SK3535-01
	0.053	59				2SK3779-01R	2SK3778-01			
300	0.28	15		2SK3580-01MR						
	0.13	32	2SK3772-01	2SK3773-01MR				2SK3774-01L	2SK3774-01S	2SK3775-01
450	2.5	3	2SK3725-01	2SK3726-01MR						
	1.6	4.3	2SK3916-01	2SK3917-01MR						
	0.65	10	2SK3514-01	2SK3515-01MR				2SK3516-01L	2SK3516-01S	
	0.38	17	2SK3692-01	2SK3693-01MR				2SK3694-01L	2SK3694-01S	2SK4040-01

The SuperFAP-G series products satisfy the quality assurance level of general consumer use.
If you intend to use the products for equipment requiring higher reliability, such as equipment for automobiles and medical equipment, please contact Fuji Electric.
Do not use the products for equipment requiring strict reliability such as aerospace equipment.

*1: $V_{GS(th)}$: Low voltage type





SuperFAP-G series

SuperFAP-G series			TO-220	TO-220F	TO-3PF	TO-247(Type:A)	T-Pack(L)	T-Pack(S)	TFP
V_{DSS} (V)	$R_{DS(on)}$ max. (Ω)	I_D (A)							
500	2.3	3.6	2SK3985-01	2SK3986-01MR			2SK3987-01L	2SK3987-01S	
	0.85	9	2SK3519-01	2SK3520-01MR 2SK4004-01MR *1			2SK3521-01L	2SK3521-01S	
	0.7	11	2SK3931-01	2SK3932-01MR			2SK3933-01L	2SK3933-01S	
	0.52	14	2SK3468-01	2SK3469-01MR			2SK3512-01L	2SK3512-01S	
	0.46	16	2SK3504-01	2SK3505-01MR			2SK3581-01L	2SK3581-01S	
	0.38	19	2SK3682-01	2SK3683-01MR		2SK3685-01	2SK3684-01L	2SK3684-01S	FML19N50G
	0.26	25			2SK3523-01R	2SK3522-01			
	0.11	51				2SK3680-01			
600	3.3	3	2SK3988-01	2SK3989-01MR			2SK3990-01L	2SK3990-01S	
	1.2	8	2SK3524-01	2SK3525-01MR			2SK3526-01L	2SK3526-01S	
	1	9	2SK3887-01	2SK3888-01MR			2SK3889-01L	2SK3889-01S	
	0.75	12	2SK3501-01	2SK3502-01MR			2SK3513-01L	2SK3513-01S	
	0.65	13	2SK3450-01	2SK3451-01MR	2SK3753-01R				
	0.57	16	2SK3686-01	2SK3687-01MR		2SK3689-01	2SK3688-01L	2SK3688-01S	
	0.37	21			2SK3528-01R	2SK3527-01			
	0.16	43				2SK3681-01			
700	0.6	17			2SK3891-01R				
900	8	2.2	2SK3727-01	2SK3728-01MR					
	6.4	2.6	2SK3981-01	2SK3982-01MR			2SK3983-01L	2SK3983-01S	
	4.3	3.7	2SK3698-01	2SK3699-01MR					
	2.5	6					2SK3676-01L	2SK3676-01S	

The SuperFAP-G series products satisfy the quality assurance level of general consumer use. If you intend to use the products for equipment requiring higher reliability, such as equipment for automobiles and medical equipment, please contact Fuji Electric. Do not use the products for equipment requiring strict reliability such as aerospace equipment.





*1: $V_{GS(th)}$: Low voltage type

■ SuperFAP-G series

SuperFAP-G Built-in FRED series			TO-220	TO-220F	TO-247(Type:A)	T-Pack(L)	T-Pack(S)
V_{DSS} (V)	$R_{DS(on)}$ max. (Ω)	I_D (A)					
500	0.55	13	2SK3695-01	2SK3696-01MR			
600	0.8	11	2SK3928-01	2SK3929-01MR		2SK3930-01L	2SK3930-01S
	0.17	42			2SK3697-01		

The SuperFAP-G series products satisfy the quality assurance level of general consumer use. If you intend to use the products for equipment requiring higher reliability, such as equipment for automobiles and medical equipment, please contact Fuji Electric. Do not use the products for equipment requiring strict reliability such as aerospace equipment.

■ Trench Power MOSFET

Trench Power MOSFET series			TO-220	TO-220F	TO-3P	TO-247(Type:A)	T-Pack(L)	T-Pack(S)
V_{DSS} (V)	$R_{DS(on)}$ max. (Ω)	I_D (A)						
40	0.006	70				2SK4068-01		
60	0.0065	70		2SK3273-01MR				
		80	2SK3270-01				2SK3272-01L	2SK3272-01S 2SK4047-01S
		100		2SK3271-01				
75	0.0079	70		2SK3730-01MR				
	0.0085	70						2SK3804-01S
100	0.0067	80						FMC80N10R6
		100				FMY100N10R6		
	0.0128	80	FMP80N10T2	FMA80N10T2			FMI80N10T2	FMC80N10T2
150	0.0245	65	FMP65N15T2	FMA65N15T2			FMI65N15T2	FMC65N15T2
200	0.047	49	FMP49N20T2	FMA49N20T2			FMI49N20T2	FMC49N20T2

The Trench Power MOSFET series products satisfy the quality assurance level of general consumer use. If you intend to use the products for equipment requiring higher reliability, such as equipment for automobiles and medical equipment, please contact Fuji Electric. Do not use the products for equipment requiring strict reliability such as aerospace equipment.

Automotive Super J MOS[®] S2 series





Automotive Super J MOS [®] S2 series			TO-247(Type:A)	T-Pack(S)
V_{DSS} (V)	$R_{DS(on)}$ max.(Ω)	I_D (A)		
600	0.190	15.5		FMC60N190S2A
	0.160	17.9	FMY60N160S2A	FMC60N160S2A
	0.125	22.8	FMY60N125S2A	FMC60N125S2A
	0.099	29.3	FMY60N099S2A	FMC60N099S2A
	0.088	32.8	FMY60N088S2A	FMC60N088S2A
	0.079	37.1	FMY60N079S2A	FMC60N079S2A
	0.070	39.4	FMY60N070S2A	
	0.040	66.2	FMY60N040S2A	
	0.025	95.5	FMY60N025S2A	

The Automotive Super J MOS[®] S2 series of products satisfy the quality assurance level of general automobile use (conforms to AEC-Q101). Do not use the products for equipment requiring strict reliability such as aerospace equipment.

Automotive Super J MOS[®] S2FD series (Built-in FRED Type)



Automotive Super J MOS [®] S2FD series (Built-in FRED Type)			TO-247(Type:A)	T-Pack(S)
V_{DSS} (V)	$R_{DS(on)}$ max. (Ω)	I_D (A)		
400	0.060	42.0		FMC40N060S2FDA
500	0.071	38.9	FMY50N071S2FDA	FMC50N071S2FDA
600	0.133	22.8	FMY60N133S2FDA	FMC60N133S2FDA
	0.105	29.3	FMY60N105S2FDA	FMC60N105S2FDA
	0.080	37.0	FMY60N081S2FDA	FMC60N081S2FDA

The Automotive Super J MOS[®] S2FD series of products satisfy the quality assurance level of general automobile use (conforms to AEC-Q101). Do not use the products for equipment requiring strict reliability such as aerospace equipment. Super J MOS[®] is registered trademarks of Fuji Electric.

Automotive SuperFAP-E^{3S} series



Automotive SuperFAP-E ^{3S} series			TO-247(Type:A)
V_{DSS} (V)	$R_{DS(on)}$ max. (Ω)	I_D (A)	
300	0.085	47	FMY47N30ESF *1
	0.072	50	FMY50N30ES
	0.053	67	FMY67N30ESF *1
	0.045	72	FMY72N30ES
600	0.29	22	FMY22N60ESF *1
	0.28	24	FMY24N60ES
	0.21	30	FMY30N60ESF *1
	0.2	31	FMY31N60ES
	0.17	35	FMY35N60ESF *1
	0.16	36	FMY36N60ES

*1: Built-in FRED Type

The automotive Super FAP-E^{3S} series (including the type with a built-in high-speed diode) is a quality-assured (AEC-Q101 compliant) lineup of products for general automotive use. Do not use the products for equipment requiring strict reliability such as aerospace equipment.

Automotive Trench Power MOS series

Automotive Trench Power MOSFET			TO-220	TO-220F	TO-3P	TO-247(Type:A)	T-Pack(L)	T-Pack(S)
								
V_{DSS} (V)	$R_{DS(on)}$ max. (Ω)	I_D (A)						
40	0.006	70				2SK4068-01 *1		
60	0.0065	70		2SK3273-01MR *1				
		80	2SK3270-01 *1				2SK3272-01L *1	2SK3272-01S *1 2SK4047-01S *1
		100		2SK3271-01 *1	FMY100N06T *1			
75	0.0079	70		2SK3730-01MR *1				
	0.0085							2SK3804-01S *1
100	0.0067	80						FMC80N10R6
		100				FMY100N10R6		

*1: AEC-Q101 non-compliant products
Do not use the products for equipment requiring strict reliability such as aerospace equipment.

■ Automotive IPS series (Intelligent Power Switches)

Self protection (Over current / Over temperature protection)

Device Type	Type	Channels	V _{CC} DC (V)	I _D (A)	R _{DS(on)} max.(Ω)	Status output	Package	Remarks
F5106H	High side	1	35 (50) *3	2	0.12 *1		SOP-8	Built-in Amp
F5112H				2		✓		
F5114H		2		1.6	✓	SSOP-12		
F5074H		1		80	0.005 *1	PSOP-12		
F5041	Low side	2	40	1	0.60 *2		SOP-8	
F5033				3	0.40 *2		K-Pack(S)	
F5020		2		5.9		SSOP-20		
F5018		1		8	0.14 *2		K-Pack(S)	High frequency switching version for F5018
F5042				12			T-Pack(S)	High frequency switching version for F5019
F5019		2		1.9				
F5043							✓	SOP-8
F5063L								



*1: R_{DS(on)}: V_{CC}=13V
 *2: R_{DS(on)}: V_{IN}/V_{GS}=5V
 *3: (): V_{CC} Pulse

Package Outlines, mm

TO-220

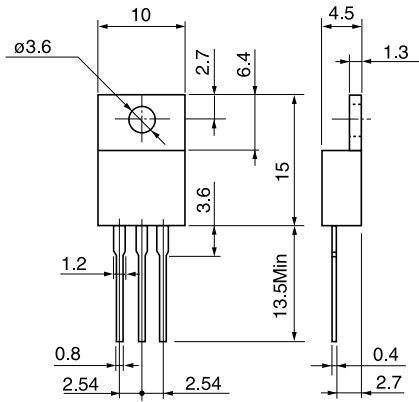

TO-220F

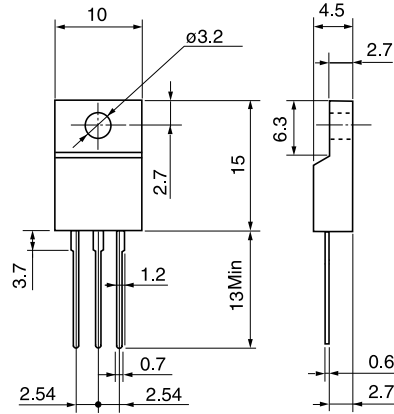

TO-220F(SLS)

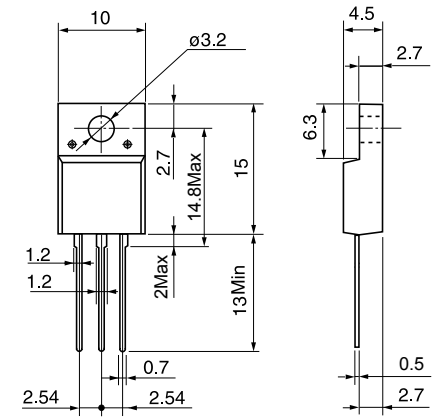

TO-3PF

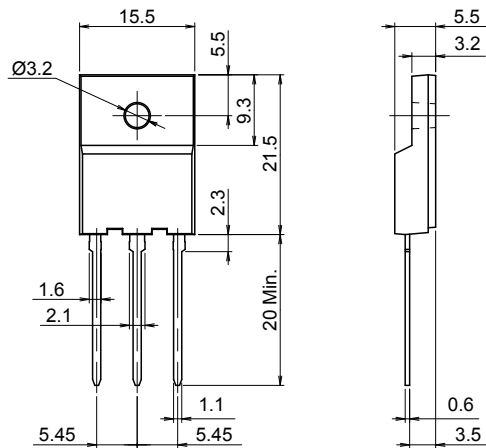

TO-3P

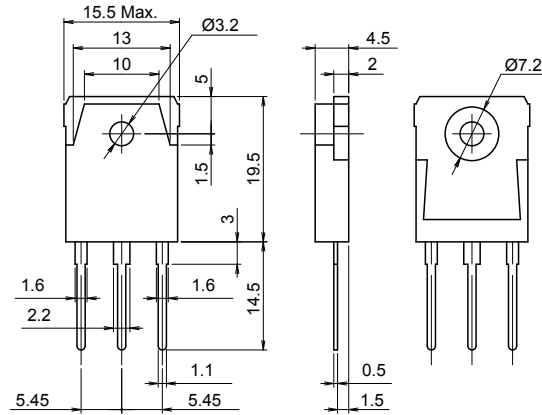

TO-3P(Q)

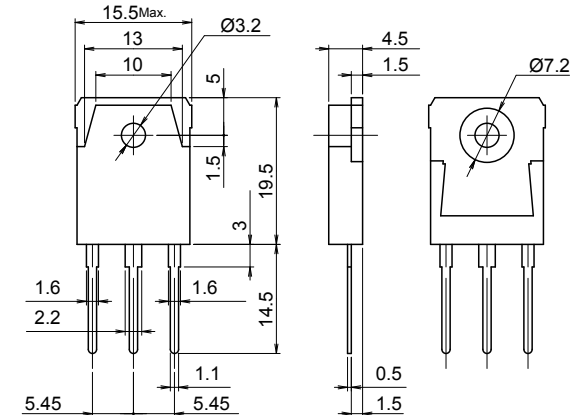

Package Outlines, mm

TO-247(Type: A)

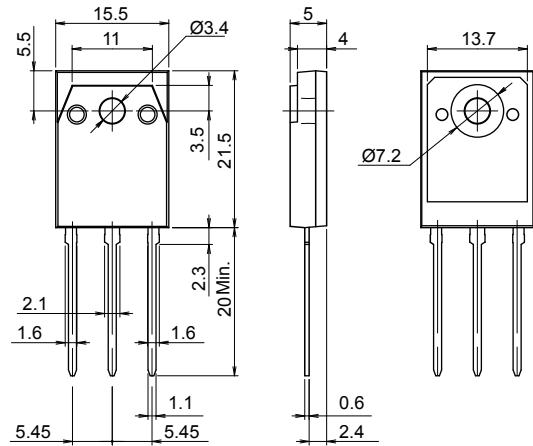

TO-247(Type: B)

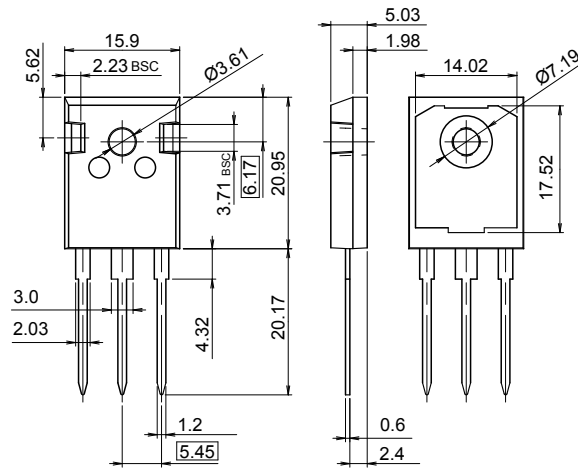

T-Pack(L)

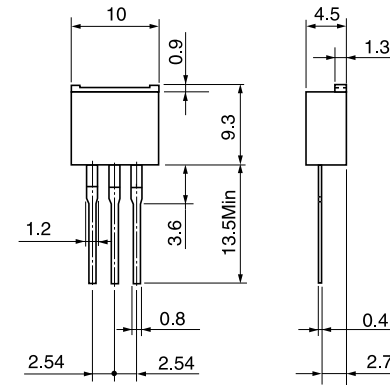

T-Pack(S)

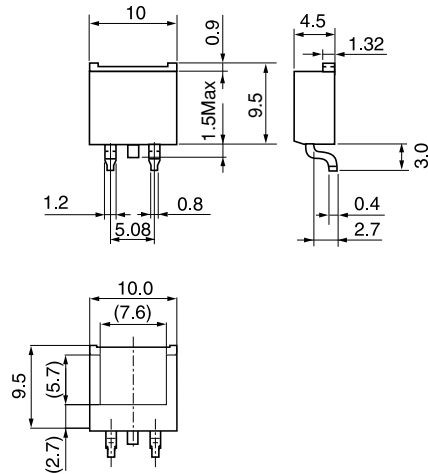

TFP

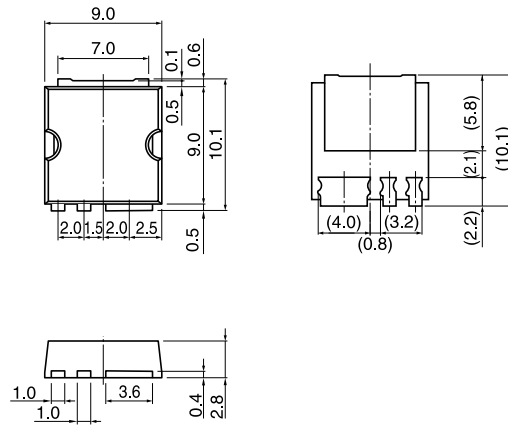

DFN8x8

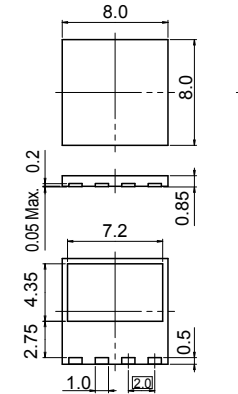

Package Outlines, mm

K-Pack(S)

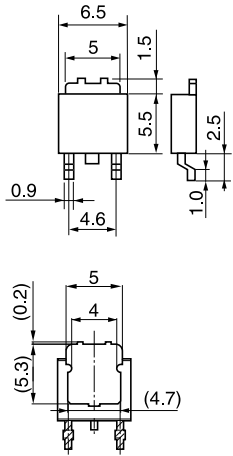

PSOP-12

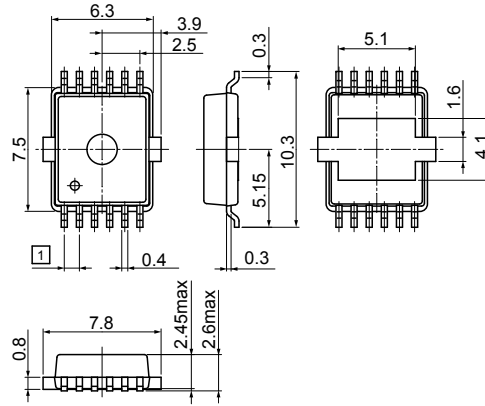

SOP-8

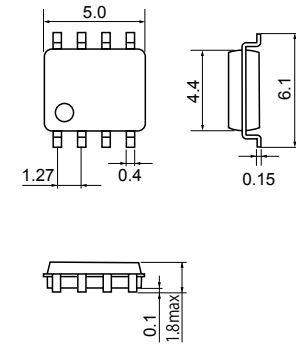

SSOP-12

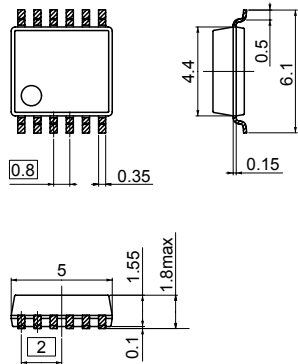

SSOP-20

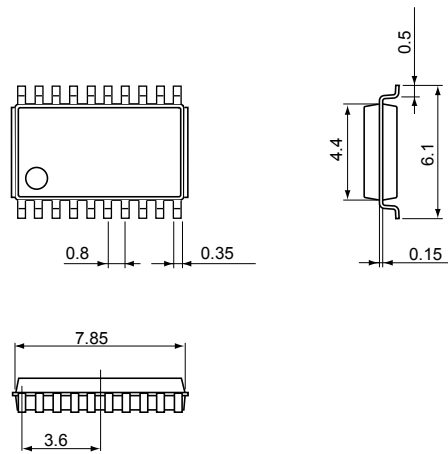

Package Outlines, mm

WARNING

1. This Catalog contains the product specifications, characteristics, data, materials, and structures as of September 2021.
The contents are subject to change without notice for specification changes or other reasons. When using a product listed in this Catalog, be sure to obtain the latest specifications.
2. All applications described in this Catalog exemplify the use of Fuji's products for your reference only. No right or license, either express or implied, under any patent, copyright, trade secret or other intellectual property right owned by Fuji Electric Co., Ltd. is (or shall be deemed) granted. Fuji Electric Co., Ltd. makes no representation or warranty, whether express or implied, relating to the infringement or alleged infringement of other's intellectual property rights which may arise from the use of the applications described herein.
3. Although Fuji Electric Co., Ltd. is enhancing product quality and reliability, a small percentage of semiconductor products may become faulty. When using Fuji Electric semiconductor products in your equipment, you are requested to take adequate safety measures to prevent the equipment from causing a physical injury, fire, or other problem if any of the products become faulty. It is recommended to make your design fail-safe, flame retardant, and free of malfunction.
4. The products introduced in this Catalog are intended for use in the following electronic and electrical equipment which have normal reliability requirements.
 - Computers
 - OA equipment
 - Communications equipment (terminal devices)
 - Measurement equipment
 - Machine tools
 - Audiovisual equipment
 - Electrical home appliances
 - Personal equipment
 - Industrial robots etc.
5. If you need to use a product in this Catalog for equipment requiring higher reliability than normal, such as for the equipment listed below, it is imperative to contact Fuji Electric Co., Ltd. to obtain prior approval. When using these products for such equipment, take adequate measures such as a backup system to prevent the equipment from malfunctioning even if a Fuji's product incorporated in the equipment becomes faulty.
 - Transportation equipment (mounted on cars and ships)
 - Trunk communications equipment
 - Traffic-signal control equipment
 - Gas leakage detectors with an auto-shut-off feature
 - Emergency equipment for responding to disasters and anti-burglary devices
 - Safety devices
 - Medical equipment
6. Do not use products in this Catalog for the equipment requiring strict reliability such as the following and equivalents to strategic equipment (without limitation).
 - Space equipment
 - Aeronautic equipment
 - Nuclear control equipment
 - Submarine repeater equipment
7. Copyright ©1996-2021 by Fuji Electric Co., Ltd. All rights reserved.
No part of this Catalog may be reproduced in any form or by any means without the express permission of Fuji Electric Co., Ltd.
8. If you have any question about any portion in this Catalog, ask Fuji Electric Co., Ltd. or its sales agents before using the product.
Neither Fuji Electric Co., Ltd. nor its agents shall be liable for any injury caused by any use of the products not in accordance with instructions set forth herein.

FE Fuji Electric Co., Ltd.

Power Semiconductors Group

www.fujielectric.com/products/semiconductor/



Head Office:

Gate City Ohsaki, East Tower, 11-2 Osaki 1-chome,
Shinagawa-ku, Tokyo 141-0032, Japan

Fuji Electric Hong Kong Co., Ltd.

Unit 1601-03 & 05, 16/F., Tower II, Grand Century Place,
No. 193 Prince Edward Road West, Mongkok, Kowloon, Hong Kong
Tel: +852-2664-8699

Fuji Electric Taiwan Co., Ltd.

10F. No.168, Song Jiang Road, Taipei, Taiwan
Tel: +886-2-2515-1820

Fuji Electric Asia Pacific Pte. Ltd.

151 Lorong Chuan, #03-01/01A New Tech Park, SINGAPORE 556741
Tel: +65-6533-0014

Fuji Electric India Private Ltd.

119(Part), 120, 120A, Electrical and Electronics Industrial Estate,
Perungudi, Chennai - 600096, Tamil Nadu, India
Tel: +91-44-40004200

Fuji Electric (China) Co., Ltd.

26F, Global Harbor Tower B,
1188 North KaiXuan Road, PuTuo District,
Shanghai 200062, P.R.China
Tel: +86-21-5496-1177

Fuji Electric Corp. of America

50 Northfield Avenue
Edison, NJ 08837, USA
Tel: +1-732-560-9410

Fuji Electric Europe GmbH

Goethering 58, 63067 Offenbach am Main, F.R. GERMANY
Tel: +49-69-6690290