

Simultaneously and continuously monitors H₂S, CH₄, CO₂, and O₂

Biomass gas analyzer <ZPAF>

Perfect system for your application

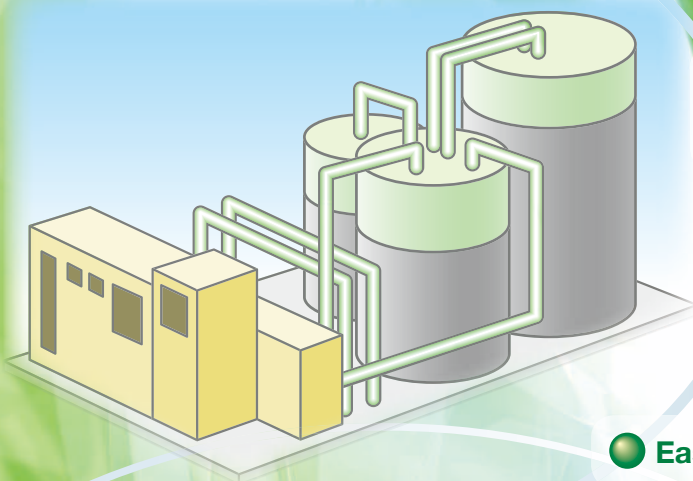

- Simultaneous and continuous measurement of 4 components: H₂S, CH₄, CO₂, O₂

- Compact and lightweight
133 × 483 × 382 mm (H×W×D),
approx. 9 kg

- Easy-to-see LCD

- A wide variety of optional functions
Automatic calibration, concentration alarm for upper and lower limit,
remote input for switching range, range identification signal output, etc.

Biomass gasification process

Biogas generated through fermentation of biomass can be used as a fuel for boilers, gas engines, and other applications.

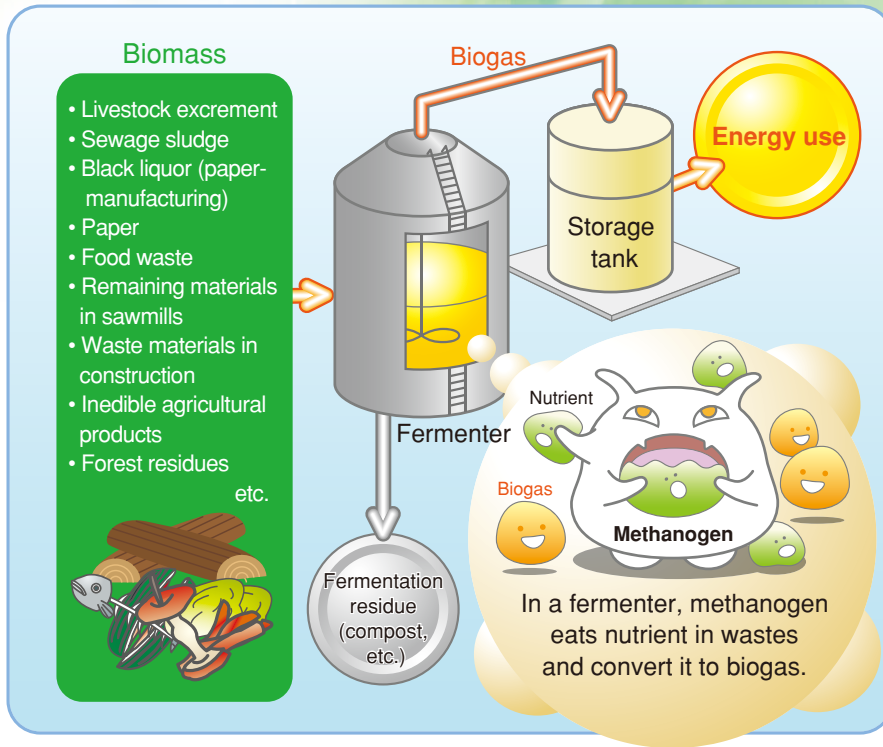

● Biogas composition

CH ₄	50 to 75 vol%
CO ₂	25 to 50 vol%
N ₂	0 to 10 vol%
H ₂	0 to 1 vol%
H ₂ S	0 to 3 vol%
O ₂	0 to 2 vol%

● Biomass resources

- Livestock excrement
- Sewage sludge
- Black liquor (paper - manufacturing)
- Paper
- Food waste
- Remaining materials in sawmills, etc.
- Waste materials in construction
- Inedible agricultural products
- Forest residues

Features

Contains 3 sensors necessary for monitoring 4 components

Target gas	Measurement range		Sensor
	1st range	2nd range	
CH ₄	0 to 20 vol%	0 to 100 vol%	Single-beam infrared sensor
CO ₂	0 to 20 vol%	0 to 100 vol%	
H ₂ S	0 to 500 ppm	0 to 2000/5000 ppm	Constant-potential electrolytic sensor
O ₂	0 to 10 vol%	0 to 25 vol%	Galvanic cell sensor

Compact and lightweight

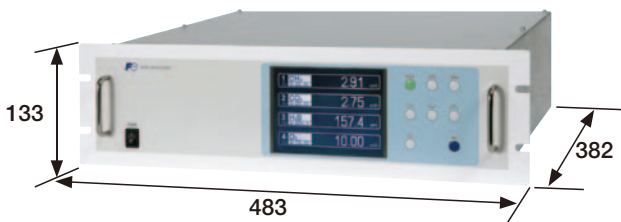

H133 x W483 x D382 mm, approx. 9 kg

Automatic calibration (optional) eliminates the need for troublesome calibration work

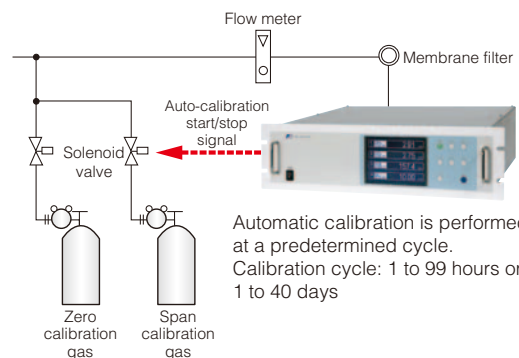

Gas concentration alarm output (optional)



RS485 (MODBUS) communication with PC (optional)

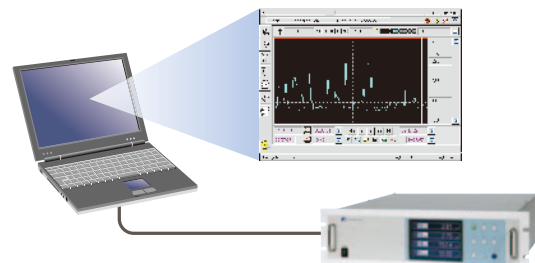

Specifications

■ Main specifications

Principle	CH ₄ , CO ₂ (Single beam NDIR sensor) O ₂ (Galvanic cell sensor) H ₂ S (constant-potential electrolytic sensor)		
Display	4-digit backlit LCD		
Components/ range	Component	1st range	2nd range
	CH ₄	0 to 20 vol%	0 to 100 vol%
	CO ₂	0 to 20 vol%	0 to 100 vol%
	H ₂ S	0 to 500 ppm	0 to 2000/5000 ppm
	O ₂	0 to 10 vol%	0 to 25 vol%
Number of measurable components	Max. 4 (simultaneous and continuous measurement)		
Analog output	4 to 20 mA DC or 0 to 1 V DC (up to 12 points)		
Contact output (optional)	1c contact (max. 15 points) Device error, calibration error, range identification, auto-calibration status, solenoid valve drive for auto-calibration, limit alarm		
Contact input (optional)	Voltage input (12 to 24 V DC) up to 9 points Remote switchover of ranges, auto-calibration remote start, remote hold		
Output hold	During calibration, output signal can be hold at the value before calibration.		
Range switchover	manual or automatic		
Power supply voltage	100 to 240 V AC, 50/60 Hz		
Power consumption	Approx. 100 VA		
Dimensions	Refer to outline drawing		
Ambient temperature	5°C to 40°C (H ₂ S and O ₂ sensors: 15°C to 40°C)		
Weight	Approx. 9kg		
Gas inlet/outlet	Rc 1/4 or NPT 1/4 internal thread		
Sensor life expectancy	O ₂ sensor: approx. 2 years H ₂ S sensor: approx. 1 year		
Certification	CE Marking		

■ Performance

Repeatability	±0.5 %FS (H ₂ S: ±2.0 %FS)
Linearity	±1 %FS (H ₂ S: ±2.0 %FS)
Zero drift	±2 %FS/week
Span drift	±2 %FS/week H ₂ S (0 to 2000 ppm) : ±2.5 %FS/week H ₂ S (0 to 5000 ppm) : ±5 %FS/day
Response (90 %FS)	10 to 30 sec. H ₂ S (0 to 2000 ppm) : 180 sec. H ₂ S (0 to 5000 ppm) : 300 sec.
Remote output hold	by external contact input

■ Functions

Range identification output	Measurement range can be identified.
Automatic zero/span calibration	can be performed at a predetermined cycle.
Auto-calibration remote start	by external digital input
Simple zero calibration	can be performed at a predetermined cycle.
Upper/lower limit alarm	output when the gas concentration reaches the preset value.
Contact output	· at device error · at calibration error · during auto calibration
Communication	RS485 communication (MODBUS)

■ Gas conditions

Flow rate	0.5 ±0.2 L/min
Temperature	10 to 50°C
Pressure	10 kPa or less
Dust	100 µg/Nm ³ or less in particle size of 0.3 µm or smaller

■ Replacement sensor

H₂S sensor	Model: ZP* TQ503691C1 (0 to 2000 ppm) Model: ZP* TQ503691C3 (0 to 5000 ppm)
O₂ sensor	Model: ZP* TQ503691C2

Principle

● Constant-potential electrolytic sensor (for H₂S)

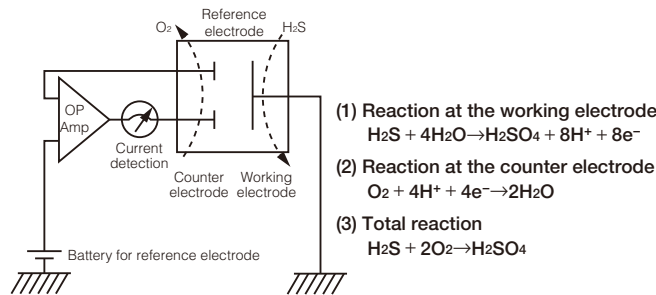

● H₂S measurement

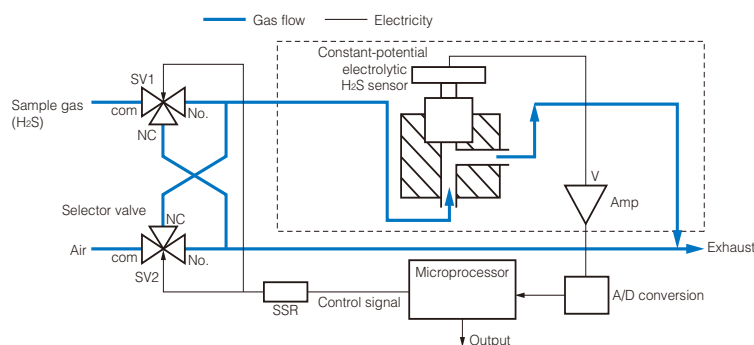

As the H₂S sensor uses constant-potential electrolytic method, there must be oxygen included in the sample gas.
 Therefore, air is supplied to the sensor at regular intervals to enable gas analysis in biogas plants where oxygen is absent, and thus stable readings are provided.

● Infrared sensor (for CO₂ and CH₄)

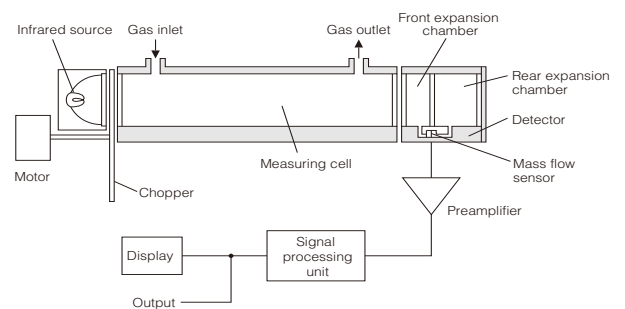

● Galvanic fuel cell sensor (for O₂)

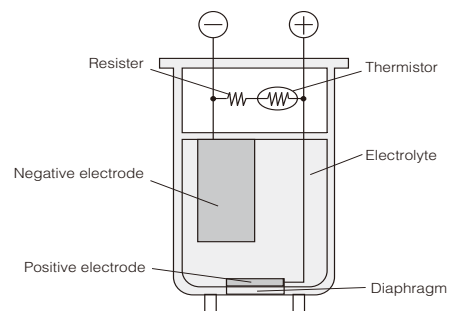

Model Specifications

4 5 6 7 8 9 10 11 12 13 14 15 16 17 18 19 20 21 22 23 24 25 ← Digit
ZPA **F****B** **1** . **Y** . **Y****Y****Y** . **Y****Y****A****G**

Digit	Specifications	Code
4	Specification	Biomass gas
5	Installation	19-inch rack mount
6	Measured components (CH ₄ , CO ₂)	none
		CO ₂ (1st component)
		CH ₄ (1st component)
		CO ₂ (1st component)+CH ₄ (2nd component)
7	Measured components (O ₂ , H ₂ S)	H ₂ S
		O ₂ + H ₂ S
8	Revision code	1
9	Measurement range (1st component 1st range)	none
		0 to 20 vol%
10	Measurement range (1st component 2nd range)	none
		0 to 100 vol%
11	Measurement range (2nd component 1st range)	none
		0 to 20 vol%
12	Measurement range (2nd component 2nd range)	none
		0 to 100 vol%
17	Measurement range (O ₂ , H ₂ S)	0 to 10/25 vol% O ₂
		0 to 500 ppm/2000 ppm H ₂ S
		0 to 500 ppm/5000 ppm H ₂ S
		C + T
		C + V
18	Gas inlet/outlet size	Rc 1/4
		NPT 1/4

Digit	Specifications	Code				
19	Output signal	0 to 1 V DC				
		4 to 20 mA DC				
		0 to 1 V DC + RS485 communication				
		4 to 20mA DC + RS485 communication				
20	Language/Power cable	Japanese/Power cable rated 125 V (PSE)				
		English/Power cable rated 125 V (UL)				
		English/Power cable rated 250V (CEE)				
		Chinese/Power cable rated 250V (CCC)				
21	-	Y				
22	Optional functions (DIO)	FAULT	Auto calibration	Upper/lower limit alarm	Range identification	
		-	-	-	-	Y
		○	-	-	-	A
		○	○	-	-	B
		○	-	○	-	C
		○	-	-	○	D
		○	○	○	-	E
		○	-	○	○	F
		○	○	-	○	G
		○	○	○	○	H
23	-	Y				
24	Unit	ppm, vol%	A			
25	Adjustment	Biogas	G			

Dimensions (unit: mm)

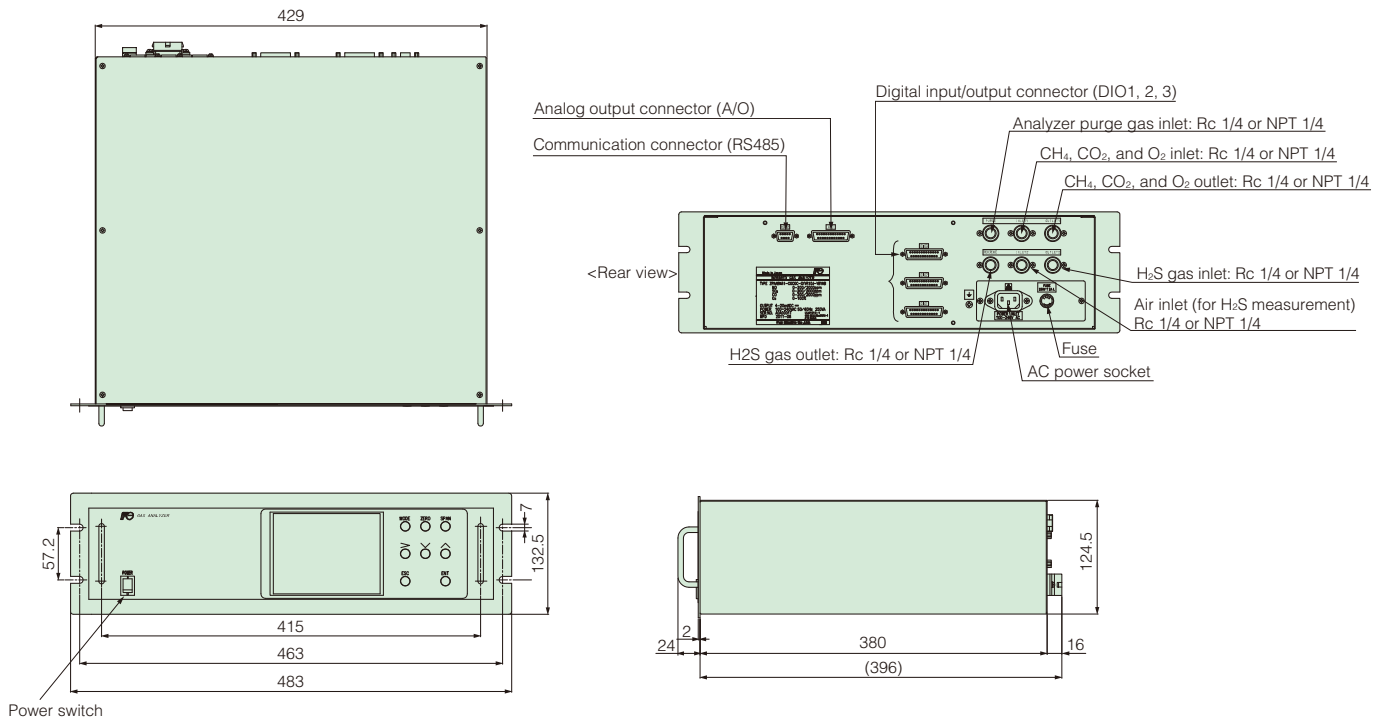

FE Fuji Electric Co., Ltd.

Grobal Sales Section

Instrumentation & Sensors Planning Dept.

1, Fuji-machi, Hino-city, Tokyo 191-8502, Japan

<http://www.fujielectric.com>

Phone: +81-42-514-8930 Fax: +81-42-583-8275

<http://www.fujielectric.com/products/instruments/>