

Instruction Manual

FRENIC-AQUA

⚠ CAUTION

Thank you for purchasing our FRENIC-AQUA series of inverters.

- This product is designed to drive a three-phase induction motor. Read through this manual to become familiar with the handling procedure and correct use.
- Improper handling might result in incorrect operation, short life cycle, or failure of this product as well as the motor.
- Deliver this manual to the end user of this product. Keep this manual in a safe place until this product is discarded.
- For instructions on how to use an optional device, refer to the instruction and installation manuals for that optional device.

Fuji Electric Co., Ltd.

INR-SI47-1611c-E

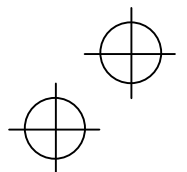
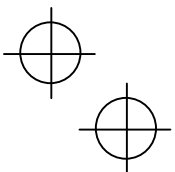

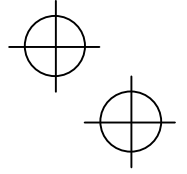
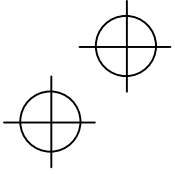

Copyright © 2012-2014 Fuji Electric Co., Ltd.

All rights reserved.

No part of this publication may be reproduced or copied without prior written permission from Fuji Electric Co., Ltd.

All products and company names mentioned in this manual are trademarks or registered trademarks of their respective holders.

The information contained herein is subject to change without prior notice for improvement.

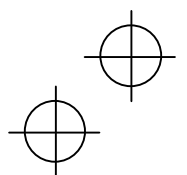
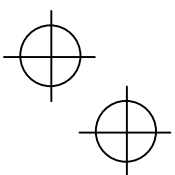

Chapter 1 BEFORE USE

1.1 Acceptance Inspection and Appearance of Product

Unpack the package and check the following:

- (1) An inverter and the following accessories are contained in the package.
Accessories: Instruction manual (this book) and CD-ROM manual
- (2) The inverter has not been damaged during transportation—there should be no dents or parts missing.
- (3) The inverter is the type you ordered. You can check the type and specifications on the main nameplate. (A total of four nameplates and warning plates are attached to the inverter as shown below.)

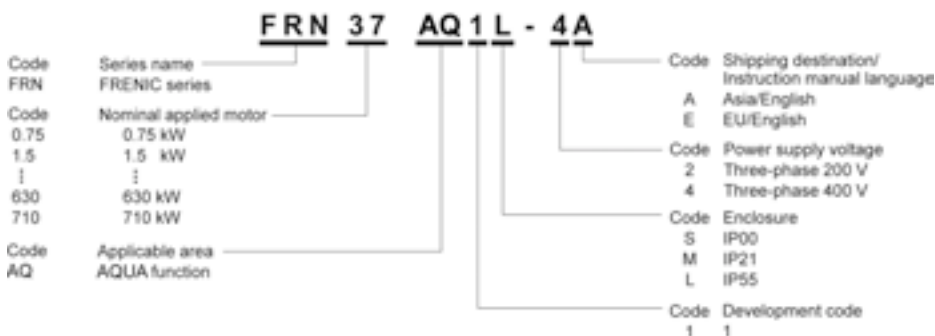
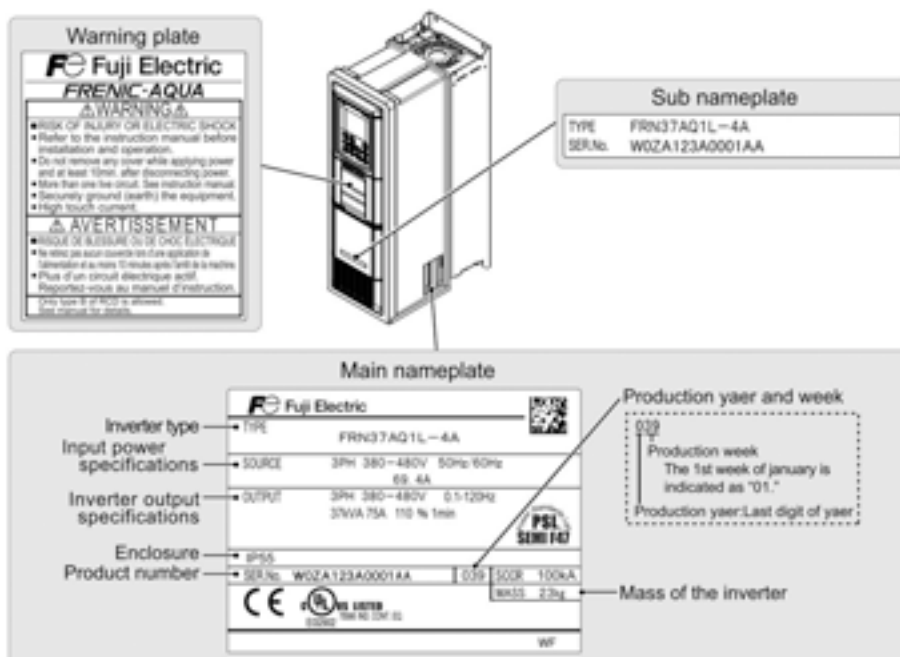

Note In this manual, inverter types are denoted as "FRN_ _AQ1■-4□." The boxes ■ and □ replace alphabetic letters depending on the enclosure and shipping destination, respectively.

If you suspect the product is not working properly or if you have any questions about your product, contact your Fuji Electric representative.

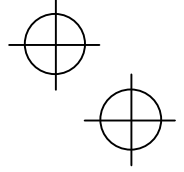
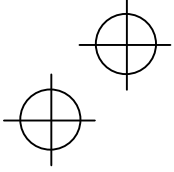

1.2 Precautions for Using Inverters

When handling inverters, be sure to observe the wiring precautions given below.

- (1) If more than one motor is to be connected to a single inverter, the wiring length should be the sum of the length of the wires to the motors.
- (2) Precautions for high frequency leakage currents

If the wiring distance between an inverter and a motor is long, high frequency currents flowing through stray capacitance across wires of phases may cause an inverter overheat, overcurrent trip, increase of leakage current, or it may not assure the accuracy in measuring leakage current. Depending on the operating condition, an excessive leakage current may damage the inverter.

To avoid the above problems when directly connecting an inverter to a motor, keep the wiring distance 50 m or less for inverters of 3.7 kW or below, and 100 m or less for inverters with a higher capacity.

If the wiring distance longer than the specified above is required, lower the carrier frequency or insert an output circuit filter (OFL-□□□-□A) as shown below.

When the inverter drives two or more motors connected in parallel (group drive), in particular, using shielded wires, the stray capacitance to the earth is large, so lower the carrier frequency or insert an output circuit filter (OFL-□□□-□A).

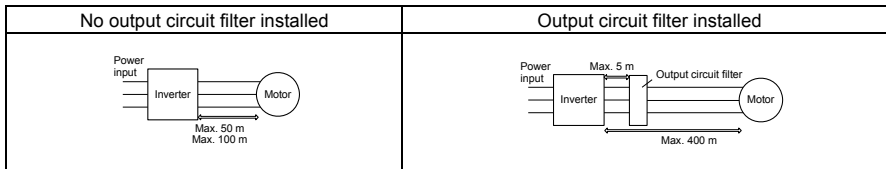

For an inverter with an output circuit filter installed, the total secondary wiring length should be 400 m or less.

If longer secondary wiring is required, consult your Fuji Electric representative.

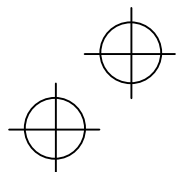
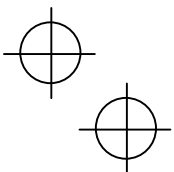

1.3 Usage environment and Strage enviroment

This section provides precautions in introducing inverters, e.g. precautions for installtion environment and strage environment.

1.3.1 Usage environment

Install the inverter in an environment that satisfies the requirements listed in Table.

Three-phase 200 V class series
0.75 to 90kW

Environmental Requirements	Site location	Indoors					
	Ambient temperature	IP00/IP21	-10 to +50°C				
		IP55	-10 to +40°C				
	Relative humidity	5 to 95% (No condensation)					
	Atmosphere	The inverter must not be exposed to dust, direct sunlight, corrosive gases, flammable gases, oil mist, vapor or water drops. Pollution degree 2 (IEC/EN 60664-1) (*1) The atmosphere can contain a small amount of salt. (0.01 mg/cm ² or less per year) The inverter must not be subjected to sudden changes in temperature that will cause condensation to form.					
	Altitude	1,000 m max. (*2)					
	Atmospheric pressure	86 to 106 kPa					
	Vibration		45 kW or less	55 to 75 kW	90kW		
			3 mm 2 to less than 9 Hz	3 mm 2 to less than 9 Hz	3 mm 2 to less than 9 Hz		
			10 m/s ² 9 to less than 200 Hz	9.8 m/s ² 9 to less than 20 Hz	2 m/s ² 9 to less than 55 Hz		
		2 m/s ² 20 to less than 55 Hz	1 m/s ² 55 to less than 200 Hz				
		1 m/s ² 55 to less than 200 Hz					

Three-phase 400 V class series
0.75 to 710kW

Environmental Requirements	Site location	Indoors					
	Ambient temperature	IP00/IP21	-10 to +50°C				
		IP55	-10 to +40°C				
	Relative humidity	5 to 95% (No condensation)					
	Atmosphere	The inverter must not be exposed to dust, direct sunlight, corrosive gases, flammable gases, oil mist, vapor or water drops. Pollution degree 2 (IEC/EN 60664-1) (*1) The atmosphere can contain a small amount of salt. (0.01 mg/cm ² or less per year) The inverter must not be subjected to sudden changes in temperature that will cause condensation to form.					
	Altitude	1,000 m max. (*2)					
	Atmospheric pressure	86 to 106 kPa					
	Vibration		90 kW or less	110 to 710 kW			
			3 mm 2 to less than 9 Hz	3 mm 2 to less than 9 Hz			
			10 m/s ² 9 to less than 200 Hz	2 m/s ² 9 to less than 55 Hz			
		1 m/s ² 55 to less than 200 Hz					

(*1) Do not install the inverter in an environment where it may be exposed to lint, cotton waste or moist dust or dirt which will clog the heat sink of the inverter. If the inverter is to be used in such an environment, install it in a dustproof panel of your system.

(*2) If you use the inverter in an altitude above 1000 m, you should apply an output current derating factor as listed in the table below.

Altitude	1000 m or lower	1000 to 1500 m	1500 to 2000 m	2000 to 2500 m	2500 to 3000 m
Output current derating factor	1.00	0.97	0.95	0.91	0.88

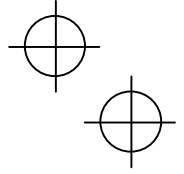
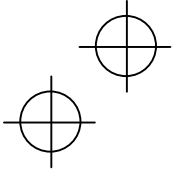

1.3.2 Storage environment

The storage environment in which the inverter should be stored after purchase differs from the usage environment. Store the inverter in an environment that satisfies the requirements listed below.

[1] Temporary storage

Storage and Transport Environments

Item	Specifications	
Storage temperature *1	During transport: -25 to +70°C	Places not subjected to abrupt temperature changes or condensation or freezing
	During storage: -25 to +65°C	
Relative humidity	5 to 95% RH *2	
Atmosphere	The inverter must not be exposed to dust, direct sunlight, corrosive or flammable gases, oil mist, vapor, water drops or vibration. The atmosphere must contain only a low level of salt. (0.01 mg/cm ² or less per year)	
Atmospheric pressure	86 to 106 kPa (during storage)	
	70 to 106 kPa (during transportation)	

*1 Assuming comparatively short time storage, e.g., during transportation or the like.

*2 Even if the humidity is within the specified requirements, avoid such places where the inverter will be subjected to sudden changes in temperature that will cause condensation or freezing.

Precautions for temporary storage

- (1) Do not leave the inverter directly on the floor.
- (2) If the environment does not satisfy the specified requirements listed in the "Storage and Transport Environments" table, wrap the inverter in an airtight vinyl sheet or similar protective wrapping for storage.
- (3) If the inverter is to be stored in a high-humidity environment, put a drying agent (such as silica gel) in the airtight package described in (2) above.

[2] Long-term storage

The long-term storage method of the inverter varies largely according to the environment of the storage site. General storage methods are described below.

- (1) The storage site must satisfy the requirements specified for temporary storage.
However, for storage exceeding three months, the surrounding temperature range should be within the range from -10 to +30°C. This is to prevent electrolytic capacitors in the inverter from deterioration.
- (2) The package must be airtight to protect the inverter from moisture. Add a drying agent inside the package to maintain the relative humidity inside the package within 70%.
- (3) If the inverter has been installed to the equipment or panel at construction sites where it may be subjected to humidity, dust or dirt, then temporarily remove the inverter and store it in the environment specified in the "Storage and Transport Environments" table.

Precautions for storage over 1 year

If the inverter has not been powered on for a long time, the property of the electrolytic capacitors may deteriorate. Power the inverters on once a year and keep the inverters powering on for 30 to 60 minutes. Do not connect the inverters to the load circuit (secondary side) or run the inverter.

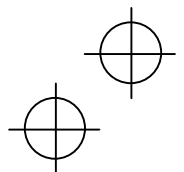
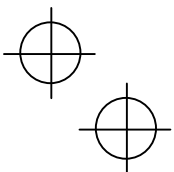

Chapter 2 MOUNTING AND WIRING THE INVERTER

2.1 Installing the Inverter

(1) Mounting base

Install the inverter on a base made of metal or other non-flammable material. Do not mount the inverter upside down or horizontally.

(2) Clearances

Ensure that the minimum clearances indicated in Figure 2.1 and Table 2.1 are maintained at all times. When installing the inverter in the panel of your system, take extra care with ventilation inside the panel as the ambient temperature easily rises. Do not install the inverter in a small panel with poor ventilation.

■ When mounting two or more inverters

When mounting two or more inverters in the same unit or panel, basically lay them out side by side. When mounting them one above the other, be sure to separate them with a partition plate or the like so that any heat radiating from one inverter will not affect the one(s) above.



Figure 2.1 Mounting Direction and Required Clearances

Table 2.1 Clearances mm (inch)

Inverter capacity	A	B	C
200Vclass series : 0.75 to 45 kW 400Vclass series : 0.75 to 90kW	10	100	100
200Vclass series : 55 to 90 kW 400Vclass series : 110 to 280kW	50		
400Vclass series : 315 to 710 kW		150	150

C: Space required in front of the inverter unit

2.2 Wiring

Before wiring, remove the front cover and wiring plate and then set cable glands or conduits on the wiring plate. After wiring, mount the wiring plate and front cover back into place. (The cable glands or conduits should be prepared by the customer.)

2.2.1 Removing and mounting the front cover and the wiring plate

(1) 200V class series 45 kW and 400V class series 90 kW or less

- ① Loosen the (four or six) screws on the front cover, hold the right and left ends of the front cover, and remove it towards you.
- ② Loosen the four screws on the wiring plate, hold the right and left ends of the wiring plate, and remove it downwards.

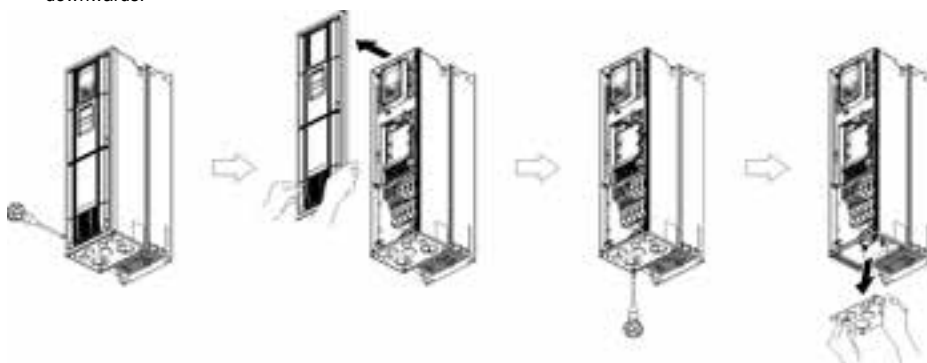
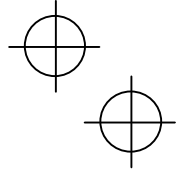
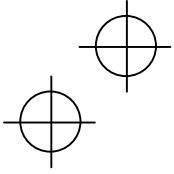

Figure 2.2 Removing the Front Cover and the Wiring Plate (FRN37AQ1M-4□)



- Tip** - The wiring plate can be removed even with the front cover being mounted.
- To expose the control printed circuit board (control PCB), remove the front cover.

(2) 200V class series 55 to 90 kW and 400V class series 110 to 710 kW

- Loosen the screws on the front cover, hold the right and left ends of the front cover, and slide it up to remove it.
- After making the necessary wiring connections, align the top of the front cover with the holes on the unit and reattach the cover by reversing the process illustrated in Figure 2.3.

- Tip** - To expose the control printed circuit board (control PCB), open the keypad case.

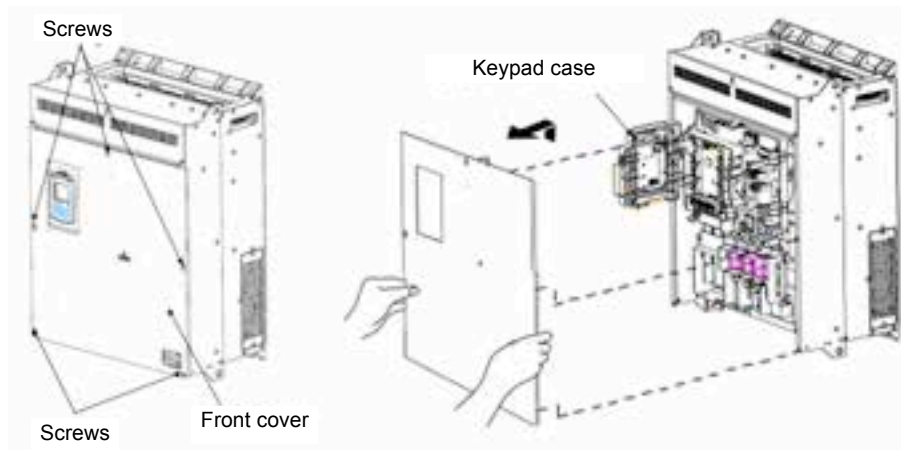

Figure 2.3 Removing the Front Cover and the Wiring Plate (FRN110AQ1S-4□)

(3) Punching out semi-perforated sections in the wiring plate and setting cable glands or conduits

- Lightly tap the semi-perforated sections from the inside of the wiring plate using the hand grip of a screwdriver or the like to punch them out.
- Set the cable glands or conduits on the wiring plate and then carry out wiring.

- Note** Take care not to get injured by the edge of the parts.

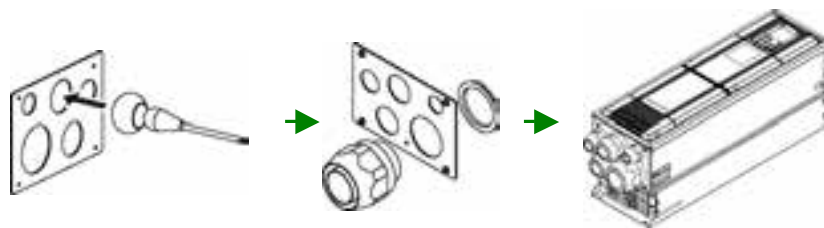
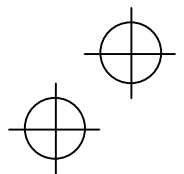
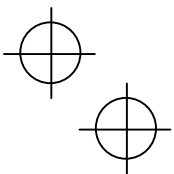
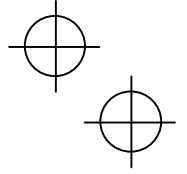
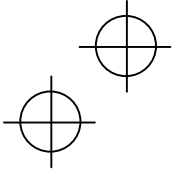

Figure 2.4 Punching Out Semi-perforated Sections in the Wiring Plate and Setting Cable Glands or Conduits





If it is difficult to punch semi-perforated sections out of the wiring plate

Apply a rod with a sharp tip (e.g., chisel) to point "A" shown below and tap it using a hammer.

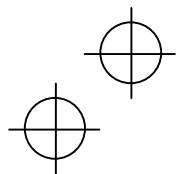
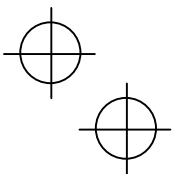
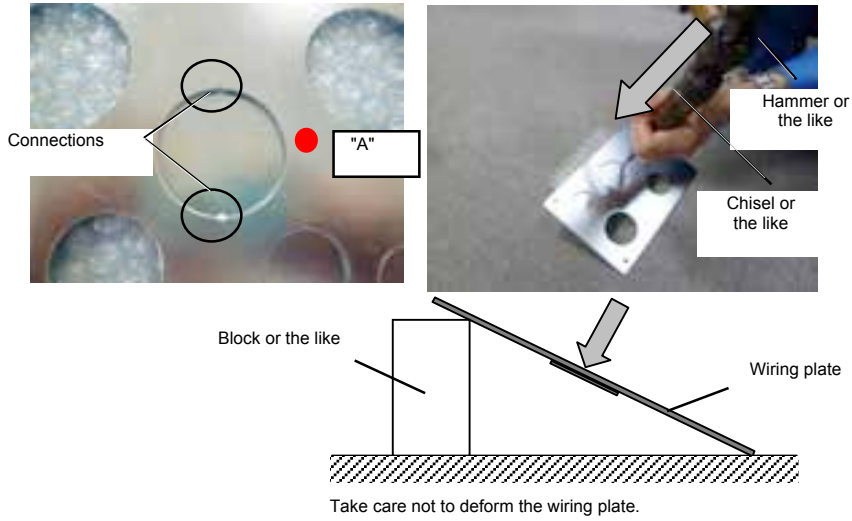

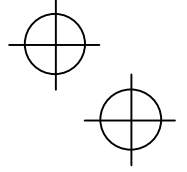
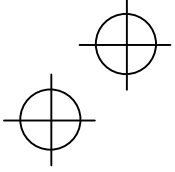

(4) Wiring the main circuit power input wires

For 200V class series inverters of 5.5 to 45 kW and 400V ones of 11 to 90 kW, follow the wiring procedure given below for smooth wiring.

- ① Remove the screws and press the ends of the ferrite core support inwards to release the ferrite core from the main circuit terminal block.
- ② Connect the inverter grounding wire.
- ③ Pass the main circuit power input wires of the inverter through the ferrite core and then connect those wires to the terminal block.
- ④ Put the ferrite core and its support back into place.

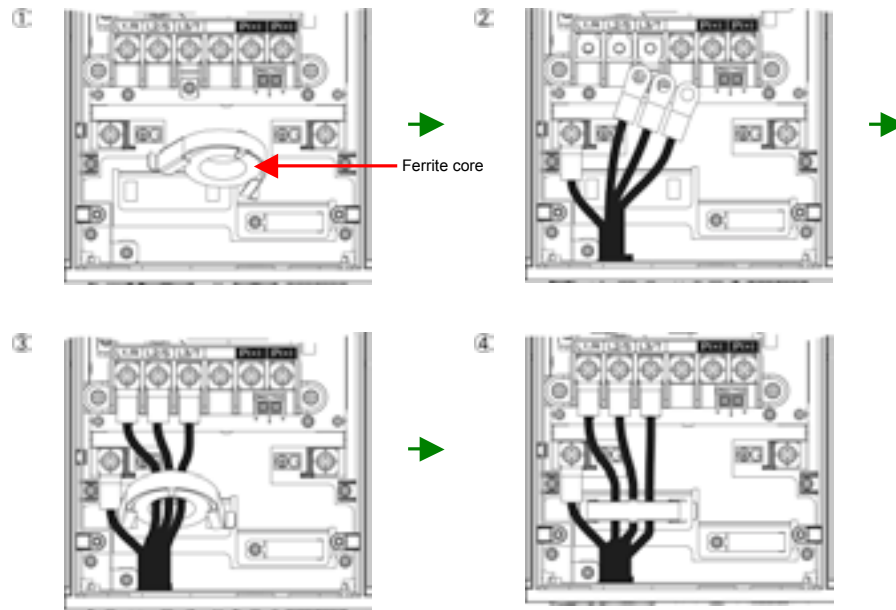

(5) Mounting the wiring plate and the front cover

After wiring, mount the wiring plate and front cover back into place.
(Tightening torque: 1.8 N•m (M4), 3.5 N•m (M5))

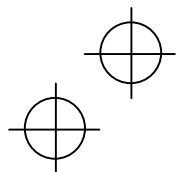
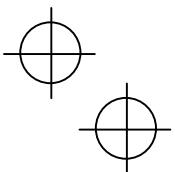

2.2.2 Recommended wire sizes

For the recommended wire sizes for the main circuits, refer to the "Conformity to the Low Voltage Directive in the EU" and "Conformity with UL standards and CSA standards (cUL-listed for Canada)" given in Preface. Crimp-style terminals for the main circuits should have insulation, insulation tubes, or similar treatment.

2.2.3 Terminal arrangement diagrams and screw specifications

The tables and figures given below show the screw specifications and terminal arrangement diagrams. Note that the terminal arrangements differ depending on the inverter capacity.

Note: Do not connect wiring to unassigned main circuit terminals that are marked with (■) in the figures given below. Doing so may break the inverter.

(1) Main circuit terminals

Table 2.2-1 Main Circuit Terminals

Power supply voltage	Nominal applied motor (kW)	Inverter type	Refer to:	Main circuit terminals		Grounding terminals		Aux. control power supply [R0, T0]		Aux main power supply [R1, T1]	
				Screw size	Tightening torque (N·m)	Screw size	Tightening torque (N·m)	Screw size	Tightening torque (N·m)	Screw size	Tightening torque (N·m)
Three-phase 200V	0.75	FRN0.75AQ1■-2□	Figure A	M4	1.8	M4	1.8	M3.5	1.2	-	-
	1.5	FRN1.5AQ1■-2□									
	2.2	FRN2.2AQ1■-2□									
	3.7 (4.0)*	FRN3.7AQ1■-2□ FRN4.0AQ1■-2E									
	5.5	FRN5.5AQ1■-2□	Figure B	M6	5.8	M6	5.8				
	7.5	FRN7.5AQ1■-2□									
	11	FRN11AQ1■-2□									
	15	FRN15AQ1■-2□	Figure C	M6	5.8	M6	5.8				
	18.5	FRN18.5AQ1■-2□									
	22	FRN22AQ1■-2□	Figure D	M8	13.5	M8	13.5				
	30	FRN30AQ1■-2□									
	37	FRN37AQ1■-2□	Figure E	M10	27	M10	27				
	45	FRN45AQ1■-2□									
55	FRN55AQ1S-2□	Figure F	M10	27	M8	13.5					
75	FRN75AQ1S-2□										
90	FRN90AQ1S-2□	Figure L	M12	48	M10	27					

* 4.0 kW for the EU. The inverter type is FRN4.0AQ1■-2E

Note: A box (■) replaces an alphabetic letter depending on the enclosure.

A box (□) replaces an alphabetic letter depending on the shipping destination.

■ Enclosure: M (IP21) or L (IP55) □ Shipping destination: E (Europe) or A (Asia)

Table 2.2-1 Main Circuit Terminals (Continued)

Power supply voltage	Nominal applied motor (kW)	Inverter type	Refer to:	Main circuit terminals		Grounding terminals		Aux. control power supply [R0, T0]		Aux main power supply [R1, T1]	
				Screw size	Tightening torque (N·m)	Screw size	Tightening torque (N·m)	Screw size	Tightening torque (N·m)	Screw size	Tightening torque (N·m)
Three-phase 400V	0.75	FRN0.75AQ1■-4□	Figure A	M4	1.8	M4	1.8	M3.5	1.2		
	1.5	FRN1.5AQ1■-4□									
	2.2	FRN2.2AQ1■-4□									
	3.7 (4.0)*	FRN3.7AQ1■-4□ FRN4.0AQ1■-4E									
	5.5	FRN5.5AQ1■-4□									
	7.5	FRN7.5AQ1■-4□	Figure B	M6	5.8	M6	5.8				
	11	FRN11AQ1■-4□									
	15	FRN15AQ1■-4□									
	18.5	FRN18.5AQ1■-4□									
	22	FRN22AQ1■-4□	Figure C	M6	5.8	M6	5.8				
	30	FRN30AQ1■-4□									
	37	FRN37AQ1■-4□	Figure D	M8	13.5	M8	13.5				
	45	FRN45AQ1■-4□									
	55	FRN55AQ1■-4□									
	75	FRN75AQ1■-4□	Figure E	M10	27	M10	27				
	90	FRN90AQ1■-4□									
	110	FRN110AQ1S-4□	Figure F	M10	27	M8	13.5				
	132	FRN132AQ1S-4□									
	160	FRN160AQ1S-4□	Figure G	M12	48	M10	27				
	200	FRN200AQ1S-4□									
220	FRN220AQ1S-4□	Figure H	M12	48	M10	27					
280	FRN280AQ1S-4□										
315	FRN315AQ1S-4□	Figure I	M12	48	M10	27					
355	FRN355AQ1S-4□										
400	FRN400AQ1S-4□										
500	FRN500AQ1S-4□	Figure J	M12	48	M10	27					
630	FRN630AQ1S-4□										
710	FRN710AQ1S-4□	Figure K	M12	48	M10	27					

* 4.0 kW for the EU. The inverter type is FRN4.0AQ1■-4E

Note: A box (■) replaces an alphabetic letter depending on the enclosure.

A box (□) replaces an alphabetic letter depending on the shipping destination.

■Enclosure: M (IP21) or L (IP55) □Shipping destination: E (Europe) or A (Asia)

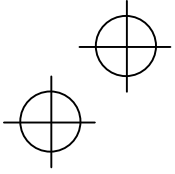

Figure A

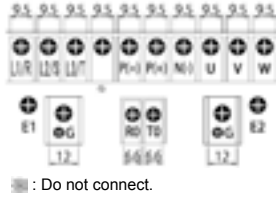

Figure B

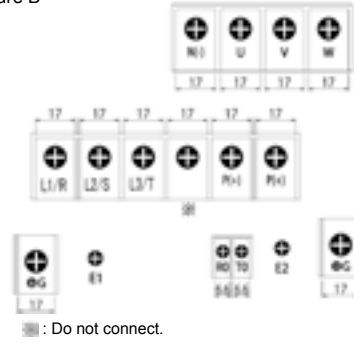

Figure C

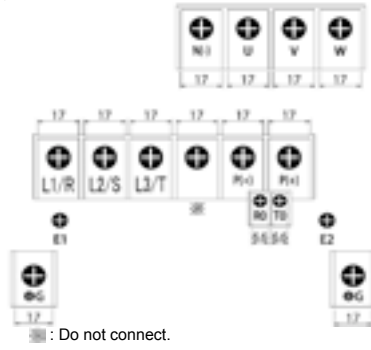

Figure D

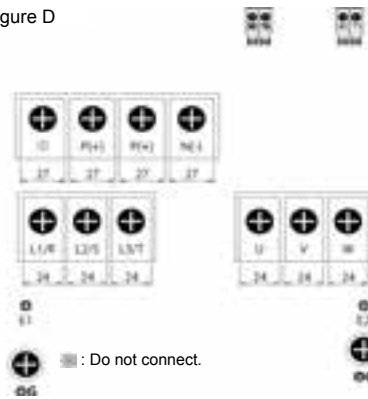

Figure E

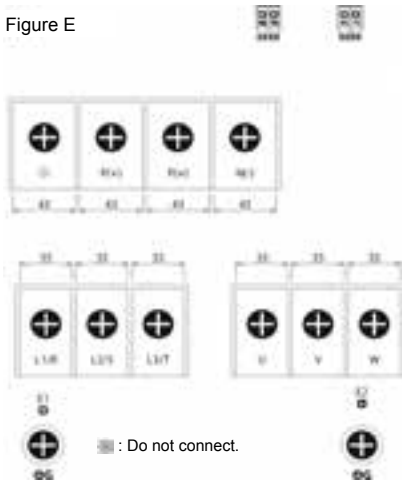
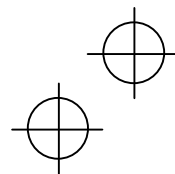
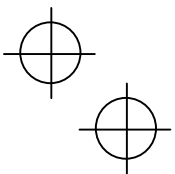
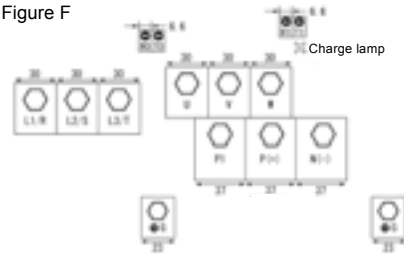

Figure F



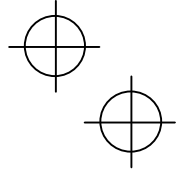
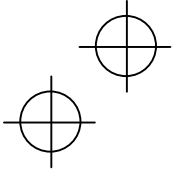
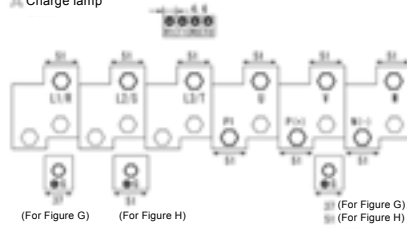

Figure G / Figure H

☒ Charge lamp



(For Figure G)

(For Figure H)

(For Figure G)
(For Figure H)

Figure I ☒ Charge lamp

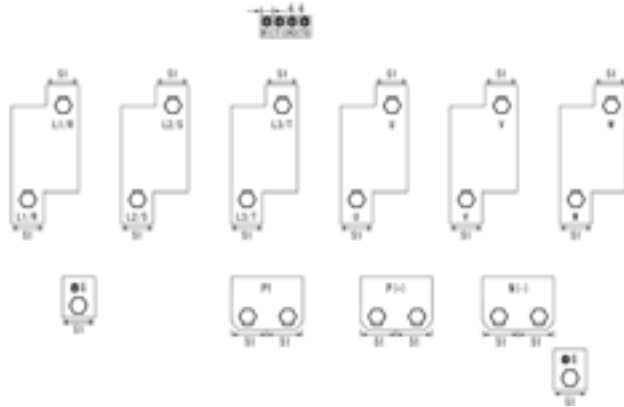

Figure J ☒ Charge lamp

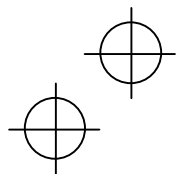
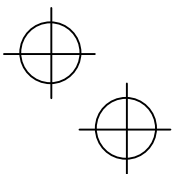
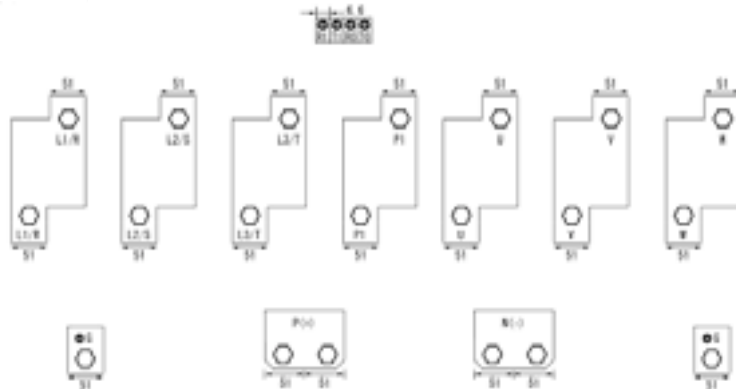

Figure K Charge lamp

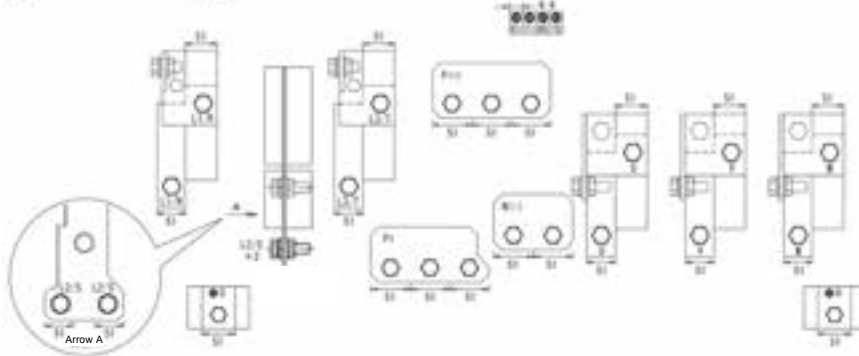
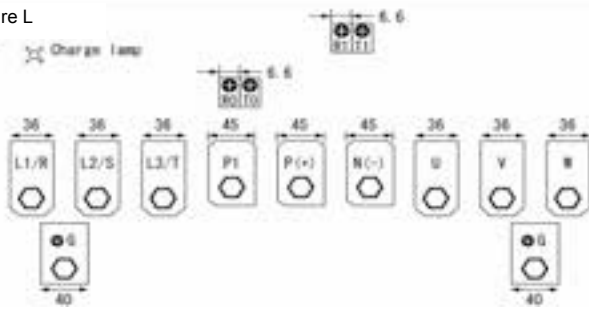
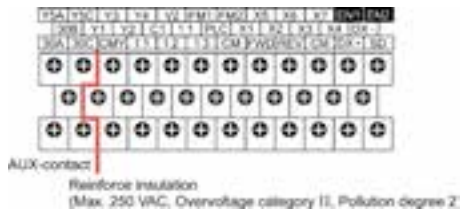

Figure L



(2) Arrangement of control circuit terminals

■ Screw type of terminal block
(Shipping destination : A (Asia))



■ Europe type of terminal block
(Shipping destination : E (Europe))

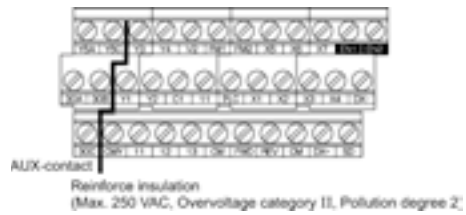

Table 2.3 Control Circuit Terminals

Terminal block type	Screw specifications		Recommended wire size (mm ²)	Type of screwdriver (tip shape)	Wire strip length	Gauge No. of wire insertion slot
	Screw size	Tightening torque				
Screw type	M3	0.7 N·m	0.75 mm ² (AWG18)	-	-	-
Europe type		0.5 to 0.6 N·m		Flat screwdriver (0.6 mm x 3.5 mm)	6 mm	A1*





*In conformity with the IEC/EN 60947-1

2.2.4 Terminal functions and wiring order

Main circuit terminals and grounding terminals

The table below shows the order of wiring and terminal functions. Carry out wiring in the order shown below.

Table 2.4 Order of Wiring and Functions of Main Circuit Terminals

Classification	Order of wiring	Name	Symbol	Functions
Main circuit (Note)	①	Primary grounding terminals for inverter enclosure	 G	Two grounding terminals ( G) are not exclusive to the power supply wiring (primary circuit) or motor wiring (secondary circuit). Be sure to ground either of the two grounding terminals for safety and noise reduction.
	②	Secondary grounding terminals for motor Inverter output terminals	 G U, V, W	Connect the secondary grounding wire for the motor to the grounding terminal ( G). Connect the three wires of the Three-phase motor to terminals U, V, and W, aligning the phases each other. (*1)
	③	Auxiliary control power input terminals	R0, T0	Connect the same AC power as for the main circuit to these terminals as a control circuit power backup.
	④	Auxiliary main power input terminals	R1, T1	It is not normally necessary to connect anything to these terminals. They are used when connecting to a DC bus. For more information, see FRENIC-AQUA User's Manual section 5.1.6 "Wiring of main circuit terminals and grounding terminals". (on 200V class series inverter of 22kW or above, and 400V ones of 45kW or above.)
	⑤	DC reactor connection terminals	P1, P(+)	Connect a DC reactor (DCR) to improve the power factor. (on 200V class series inverter of 55 to 90kW or 400V ones of 110 kW or above)
	⑥	DC link bus terminals	P(+), N(-)	A DC link bus is connectable to these terminals. When you need to use the DC link bus terminals P(+) and N(-), consult your Fuji Electric representative.
	⑦	Main circuit power input terminals	L1/R, L2/S, L3/T	The three-phase input power lines are connected to these terminals. (*2) If the power wires are connected to other terminals, the inverter will be damaged when the power is turned ON.
	⑧	Switching connectors	CN UX, CN R, CN W	These are the main circuit switching connectors. For more information, see "2.2.6 Switching connectors" in this instruction manual.
Control circuit	⑨	Control circuit terminals	See Table 2.5.	Route the wiring of the control circuit as far from that of the main circuit as possible. Otherwise, electric noise may cause malfunctions. When the Enable function is not to be used, short-circuit terminals [EN1] and [PLC] and terminals [EN2] and [PLC] using jumper wires.

(Note) Do not connect wiring to unassigned main circuit terminals (marked with NC). For details about the terminal block, refer to Section 2.2.3 "Terminal arrangement diagrams and screw specifications."

Wiring of Auxiliary control power input terminals

Auxiliary control power input terminals R0 and T0.

Terminal rating:

200V class series ; 200 to 240VAC, 50/60Hz, Maximum current 1.0A (18.5kW or below)

200V class series ; 200 to 230VAC, 50/60Hz, Maximum current 1.0A(22kW or above)

400V class series ; 380 to 480VAC, 50/60Hz, Maximum current 0.5A

Auxiliary main power input terminals R1 and T1
(on 200V class series inverters of 22 kW or above, and 400V class series inverters of 45 kW or above)

Terminal rating:

200V class series: 200 to 220 VAC /50 Hz, 200 to 230 VAC/60 Hz: Maximum current 1.0 A

400V class series: 380 to 440 VAC /50 Hz, 380 to 480 VAC/60 Hz

500 kW or below : Maximum current 1.0 A

630/710 kW : Maximum current 2.0 A

■ Wiring notes

To make the machinery or equipment compliant with the EMC standards, wire the motor and inverter in accordance with the following.

(*1) Use shielded wires for the motor cable and route the cable as short as possible. Firmly clamp the shield to the specified point inside the inverter.

(*2) When wiring the main circuit power input lines of the inverters of 200V class series inverter of 5.5 to 45kW and 400V ones of 11 to 90 kW, be sure to pass them through a ferrite core.



When shielded wires are not used for the motor cable, remove the motor cable clamps to prevent the cable covering from getting damaged, which makes the machinery or equipment noncompliant with the EMC standards. Wiring the inverter main power input lines without passing them through a ferrite core also makes the machinery or equipment incompliant with the EMC standards due to increase of noise generated by the inverter, but it does not affect inverter basic operation.

 For details about wiring, refer to Chapter 8, Section 8.3 "Compliance with EMC Standards."

Control circuit terminals

Table 2.5 Names, Symbols and Functions of the Control Circuit Terminals

Classification	Name	Symbol	Functions
Analog input	Power supply for the potentiometer	[13]	Power supply for an external frequency command potentiometer (Variable resistor: 1 to 5kΩ)
	Analog setting voltage input	[12]	External voltage input that commands the frequency externally.
	Analog setting current input PTC thermistor input	[C1]	External current input that commands the frequency externally. Connection of a PTC (Positive Temperature Coefficient) thermistor for motor protection.
	Analog setting voltage input	[V2]	External voltage input that commands the frequency externally.
	Analog common	[11]	Common terminal for analog input signals.
Digital input	Digital input 1 to Digital input 7	[X1] to [X7]	(1) Various signals such as "Coast to a stop," "Enable external alarm trip," and "Select multi-frequency" can be assigned to terminals [X1] to [X7], [FWD] and [REV] by setting function codes E01 to E07, E98, and E99. (2) Input mode, i.e. SINK and SOURCE, is changeable by using the slide switch SW1. (3) The logic value (1/0) for ON/OFF of the terminals [X1] to [X7], [FWD], or [REV] can be switched. If the logic value for ON of the terminal [X1] is "1" in the normal logic system, for example, OFF is "1" in the negative logic system and vice versa.
	Run forward command	[FWD]	Short-circuiting terminals [FWD] and [CM] runs the motor in the forward direction and opening them decelerates the motor to a stop.
	Run reverse command	[REV]	Short-circuiting terminals [REV] and [CM] runs the motor in the reverse direction and opening them decelerates the motor to a stop.

Table 2.5 Names, Symbols and Functions of the Control Circuit Terminals (continued)

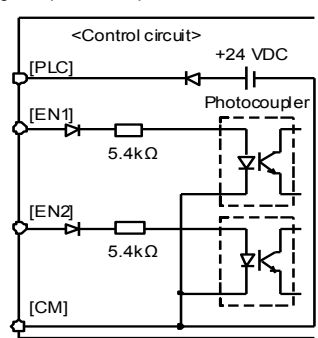
Classification	Name	Symbol	Functions														
Digital input	Enable input 1 Enable input 2	[EN1] [EN2]	<p>(1) Opening the circuit between terminals [EN1] and [PLC] or terminals [EN2] and [PLC] stops the operation of the inverter output transistor.</p> <p>(2) The input mode of terminals [EN1] and [EN2] is fixed at the SOURCE mode. No switching to the SINK mode is possible.</p> <p>(3) If either one of [EN1] and [EN2] is OFF, an alarm occurs. This alarm state can be cleared only by turning the inverter power off and on clears this alarm.</p> <p><Digital input circuit specifications></p>  <table border="1" data-bbox="766 1030 1212 1276"> <thead> <tr> <th>Item</th> <th>Min.</th> <th>Max.</th> </tr> </thead> <tbody> <tr> <td rowspan="2">Operating voltage</td> <td>ON level</td> <td>22 V 27 V</td> </tr> <tr> <td>OFF level</td> <td>0 V 2 V</td> </tr> <tr> <td>Operating current at ON (Input voltage is at 27 V)</td> <td>2.5 mA</td> <td>5 mA</td> </tr> <tr> <td>Allowable leakage current at OFF</td> <td>-</td> <td>0.5 mA</td> </tr> </tbody> </table>	Item	Min.	Max.	Operating voltage	ON level	22 V 27 V	OFF level	0 V 2 V	Operating current at ON (Input voltage is at 27 V)	2.5 mA	5 mA	Allowable leakage current at OFF	-	0.5 mA
	Item	Min.	Max.														
	Operating voltage	ON level	22 V 27 V														
OFF level		0 V 2 V															
Operating current at ON (Input voltage is at 27 V)	2.5 mA	5 mA															
Allowable leakage current at OFF	-	0.5 mA															
	PLC signal power	[PLC]	Connects to the output signal power supply of Programmable Logic Controller (PLC). Rated voltage: +24 VDC (Allowable range: +22 to +27 VDC), Maximum 200 mA DC														
	Digital input common	[CM]	Common terminals for digital input signals														
Analog output	Analog monitor	[FM1] [FM2]	These terminals output monitor signals for analog DC voltage (0 to +10 V) or analog DC current (4 to 20 mA/0 to 20 mA).														
	Analog common	[11]	Common terminal for analog output signals.														
Transistor output	Transistor output 1 to Transistor output 4	[Y1] to [Y4]	Both the SINK and SOURCE modes are supported. (1) Various signals such as "Inverter running," "Frequency arrival signal," and "Motor overload early warning" can be assigned to terminals [Y1] to [Y4] by setting function code E20 to E23. (2) The logic value (1/0) for ON/OFF of the terminals between one of [Y1] to [Y4] and [CMY] can be switched. If the logic value for ON between one of [Y1] to [Y4] and [CMY] is "1" in the normal logic system, for example, OFF is "1" in the negative logic system and vice versa.														
	Transistor output common	[CMY]	Common terminal for transistor output signals														

Classification	Name	Symbol	Functions
Relay output	General-purpose relay output	[Y5A/C]	(1) Any one of output signals that can be assigned to terminals [Y1] to [Y4] can also be assigned to this relay contact, as a general-purpose relay output. (2) Whether excitation or non-excitation causes this terminal to output an alarm can be switched.
	Alarm relay output (for any error)	[30A/B/C]	(1) When the protective function is activated, this terminal outputs a contact signal (1C) to stop the motor. (2) Any one of output signals that can be assigned to terminals [Y1] to [Y4] can also be assigned to this relay contact as a multipurpose relay output, to use it for signal output. (3) Whether excitation or non-excitation causes this terminal to output an alarm can be switched.
Communication	RS-485 communications port 2 (On the terminal block)	[DX+]/ [DX-]/ [SD]	These I/O terminals are used as a communications port that transmits data through the RS-485 multipoint protocol between the inverter and a computer or other equipment such as a PLC.
	RS-485 communications port 1 (For connection of the keypad)	RJ-45 connector	Used to connect the keypad to the inverter. The inverter supplies the power to the keypad via the extension cable for remote operation.
	USB port (On the control printed circuit board)	CN10	Used as a USB port connector (mini B) that connects the inverter to a computer. This connector enables connection with the inverter FRENIC loader program.
Battery	Battery connection	CN11	Connector for an optional battery.

2.2.5 Connection diagrams

[1] 200 V class series inverters of 45 kW or below , 400 V ones of 90 kW or below

This section shows connection diagrams with the Enable input function used.

SINK mode input by factory default

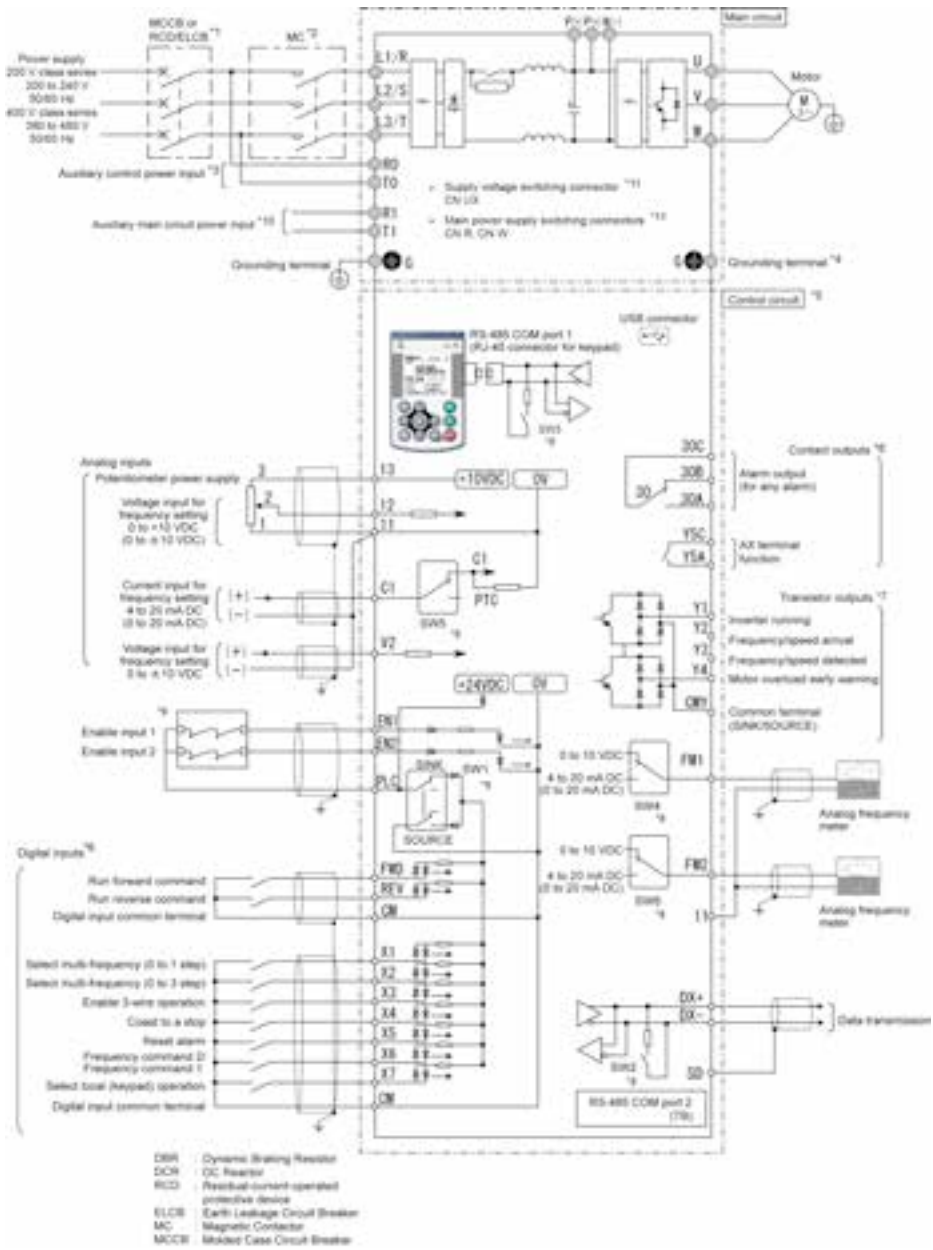

SOURCE mode input by factory default

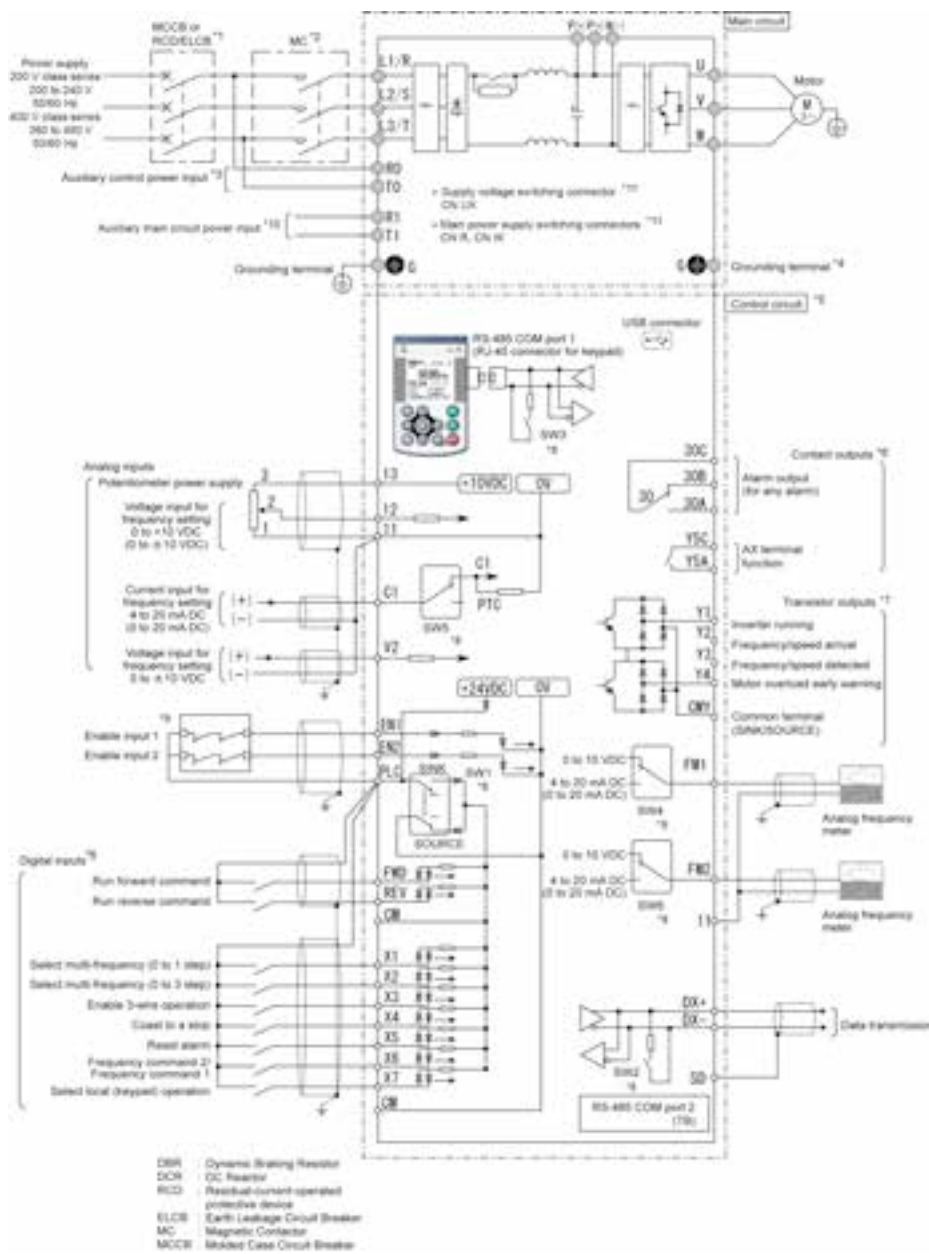

[2] 200 V class series inverters of 55 kW or above and 400 V ones of 110 kW or above

SINK mode input by factory default

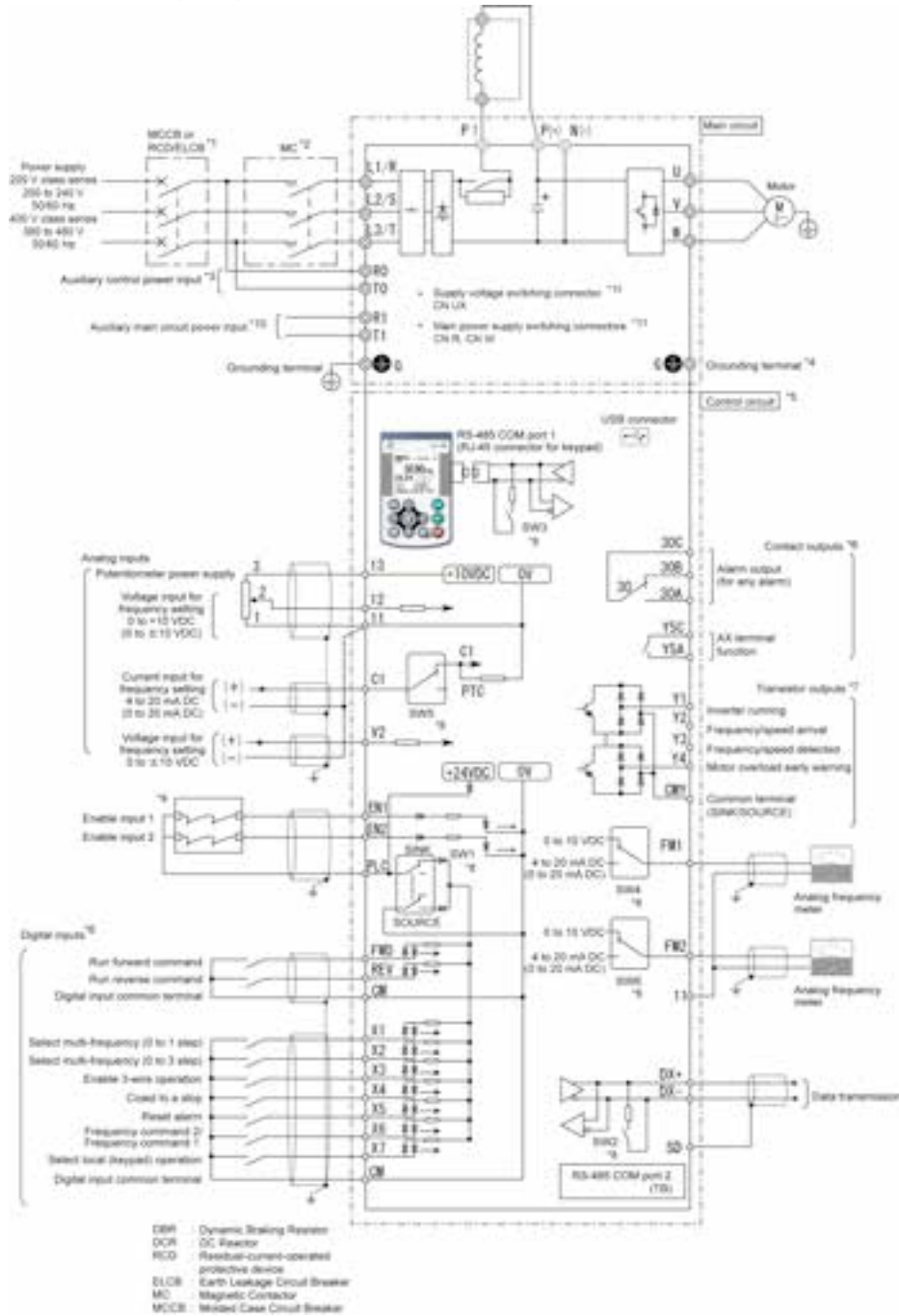

SOURCE mode input by factory default

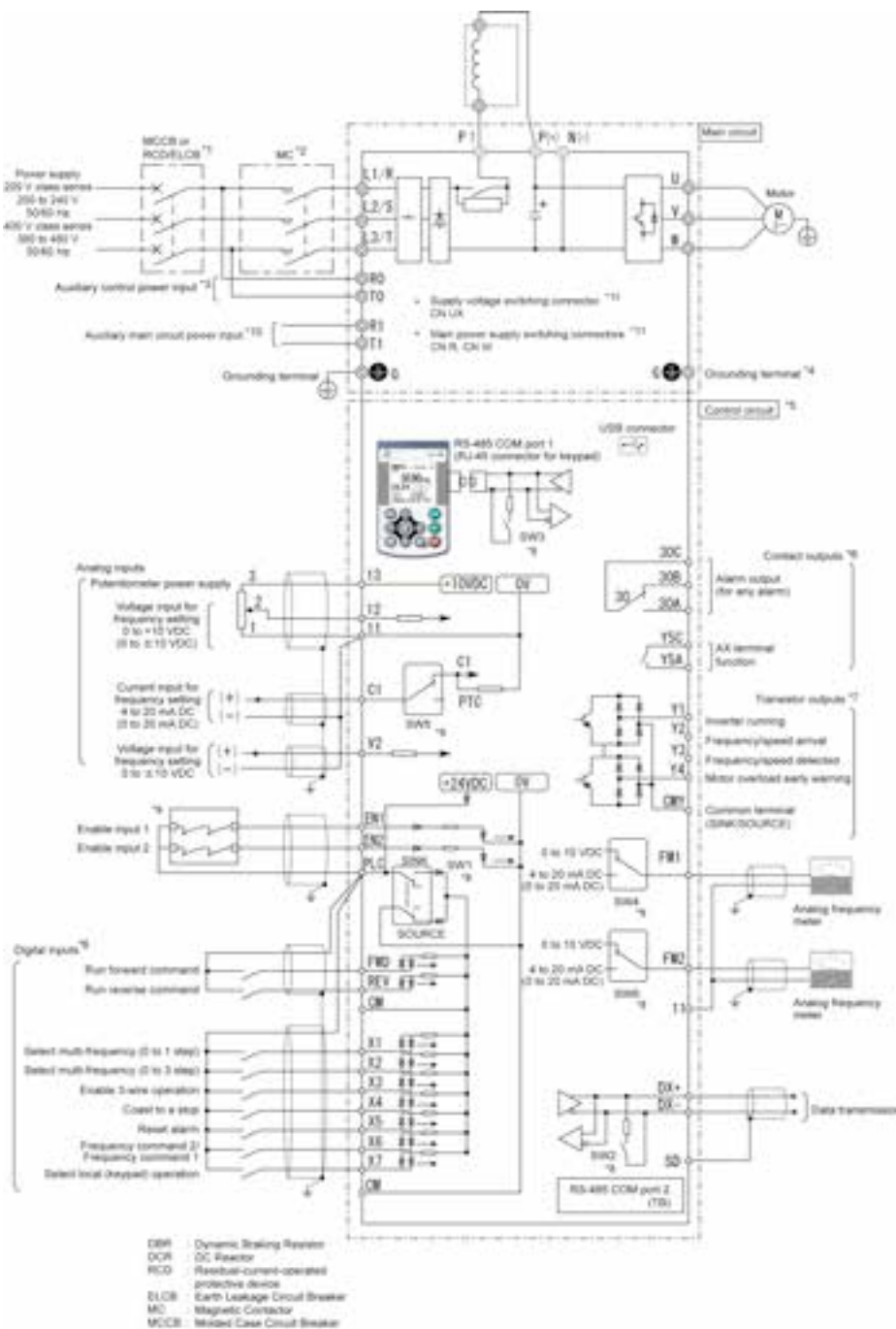

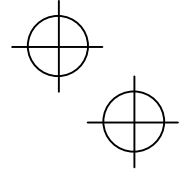
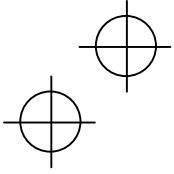

- *1 Install a recommended molded case circuit breaker (MCCB) or residual-current-operated protective device (RCD)/earth leakage circuit breaker (ELCB) (with overcurrent protection function) in the primary circuit of the inverter to protect wiring. Ensure that the circuit breaker capacity is equivalent to or lower than the recommended capacity.
- *2 Install a magnetic contactor (MC) for each inverter to separate the inverter from the power supply, apart from the MCCB or RCD/ELCB, when necessary.
Connect a surge absorber in parallel when installing a coil such as the MC or solenoid near the inverter.
- *3 To retain an alarm output signal **ALM** issued on inverter's programmable output terminals by the protective function or to keep the keypad alive even if the main power has shut down, connect these terminals to the power supply lines. Even without power supply to these terminals, the inverter can run.
When these terminals are connected to the power supply lines, shutting down the MC being used for main power ON/OFF cannot power off all live parts. Be sure to shut down all circuits with a disconnecting switch (DS).
- *4 A grounding terminal for a motor. Use this terminal if needed.
- *5 For control signal wires, use twisted or shielded-twisted wires. When using shielded-twisted wires, connect the shield of them to the common terminals of the control circuit. To prevent malfunction due to noise, keep the control circuit wiring away from the main circuit wiring as far as possible (recommended: 10 cm or more). Never install them in the same wire duct. When crossing the control circuit wiring with the main circuit wiring, cross them at right angles.
- *6 The connection diagram shows factory default functions assigned to digital input terminals [X1] to [X7], [FWD] and [REV], transistor output terminals [Y1] to [Y4], and relay contact output terminals [Y5A/C] and [30A/B/C].
- *7 Terminals [Y1] to [Y4] (transistor outputs) support both SINK and SOURCE modes. The diagrams below show the examples of circuit connection between the transistor output of the inverter's control circuit and a PLC.

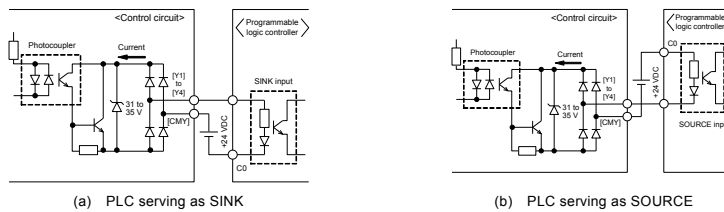

- *8 Slide switches on the control printed circuit board (control PCB). Use these switches to customize the inverter operations. For details, refer to Section 2.2.7 "Setting up the slide switches."
- *9 When the Enable function is not to be used, short-circuit terminals [EN1] and [PLC] and terminals [EN2] and [PLC] using jumper wires. For opening and closing the hardware circuit between terminals [EN1] and [PLC] and between [EN2] and [PLC], use safety components such as safety relays and safety switches. Be sure to use shielded wires exclusive to terminals [EN1] and [PLC] and terminals [EN2] and [PLC]. (Do not put them together with any other control signal wire in the same shielded core.)
- *10 It is not normally necessary to connect anything to these terminals. They are used when connecting to a DC bus. (on 200V class series inverters of 22kW or above and 400V ones of 45kW or above)
- *11 These are the main circuit switching connectors. For more information, see "2.2.6 Switching connectors" in this instruction manual.

2.2.6 Switching connectors

- Supply voltage switching connector (CN UX) (for 400 V class series inverters of 45 kW or above)

Inverters with a capacity of 400 V class series inverters of 45 kW or above have a supply voltage switching connector (CN UX). If the power supply being connected to the main circuit power input terminals (L1/R, L2/S, L3/T) or auxiliary main circuit power input terminals (R1, T1) satisfies the conditions listed below, change the CN UX connector to the U2 position. Otherwise, use the connector in the factory-default U1 position.

For more detailed switching guidelines, see Figures 2.5 and 2.6 on the following page.

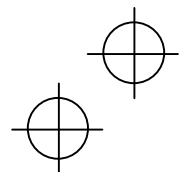
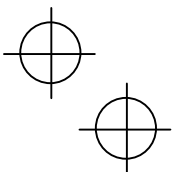

(a) 45 to 132 kW

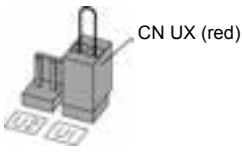
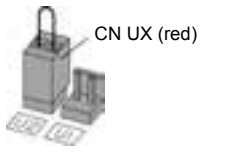
Setting		
Applied voltage	398 to 440 V/50 Hz, 430 to 480 V/60 Hz (Factory default)	380 to 398 V/50 Hz, 380 to 430 V/60 Hz

Note The allowable voltage fluctuation range is +10% to -15%.

(b) 160 to 710 kW

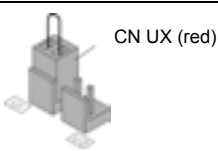
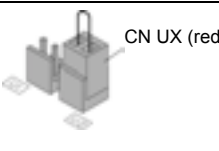
Setting		
Applied voltage	398 to 440V/50Hz, 430 to 480V/60Hz (Factory default)	380 to 398V/50Hz, 380 to 430V/60Hz

Note The allowable voltage fluctuation range is +10% to -15%.

■ Main power supply switching connectors (CN R, CN W) (for 200 V class series inverters of 22 kW or above and 400 V ones of 45 kW or above)

In its standard specifications, the FRENIC-AQUA supports DC power supply input. However, inverters with a capacity of 200 V class series inverters of 22 kW or above and 400 V ones of 45 kW or above have components that are driven internally by an AC power supply and therefore require a supply of AC power. Consequently, when using the inverter with a DC power supply, it is necessary to switch the CN R connector to the **NC** position and the CN W connector to the **73X** position (200 V class series inverters of 22 to 45 kW and 400 V ones of 45 to 90 kW or the **FAN** position (200 V class series inverters of 55 kW or above and 400 V ones of 110 kW or above), and to connect the designated AC power supply to the auxiliary main circuit power input terminals (R1, T1).

For more detailed switching guidelines, see Figures 2.5 and 2.6 on the following page.

(a) 200 V class series inverters of 22 to 45 kW and 400 V ones of 45 to 90 kW

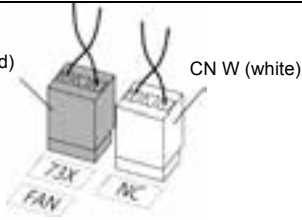
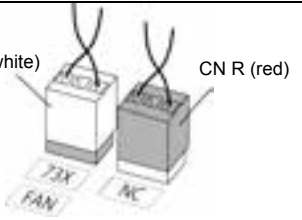
Setting		
Application	When not using the R1 and T1 terminals (Factory default)	When using the R1 and T1 terminals • DC bus input type • Used in combination with a PWM converter.

(b) 200 V class series inverters of 55 kW or above and 400 V ones of 110 kW or above

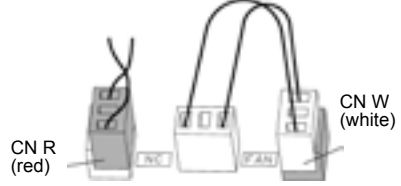
Setting		
Application	<p>When not using the R1 and T1 terminals (Factory default)</p>	<p>When using the R1 and T1 terminals</p> <ul style="list-style-type: none"> • DC bus input type • Used in combination with a PWM converter.



- In the factory-default state, the main power supply switching connector CN R is set to **73X** (200 V class series inverters of 22 to 45 kW and 400 V ones of 45 to 90 kW or **FAN** (200 V class series inverters of 55 kW or above and 400 V ones of 110 kW or above), and CN W is set to **NC**. When not using the inverter with DC power supply input, do not switch the connectors. Use of improper main power supply switching connector settings may result in a malfunction such as a cooling fin overheat (OH1) or charging circuit error (PbF).
- When using this product in combination with a PWM converter, refer to the instructions given in the FRENIC-AQUA User's Manual.

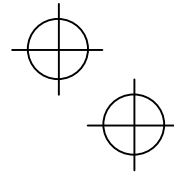
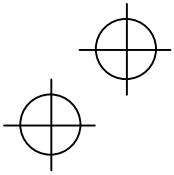

■ Connector locations

The switching connectors can be found in the following locations on the power supply printed circuit board:

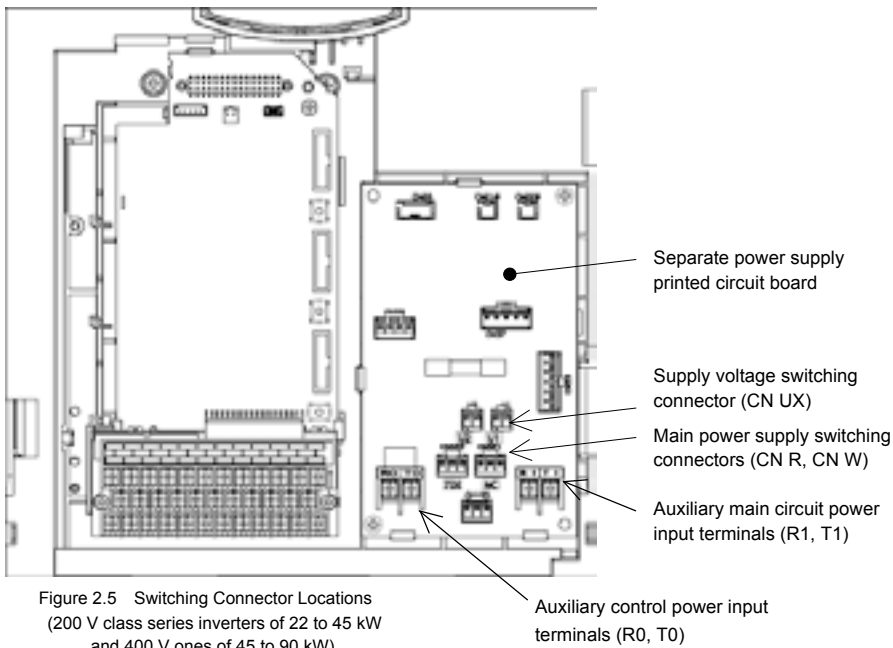

Figure 2.5 Switching Connector Locations
(200 V class series inverters of 22 to 45 kW
and 400 V ones of 45 to 90 kW)

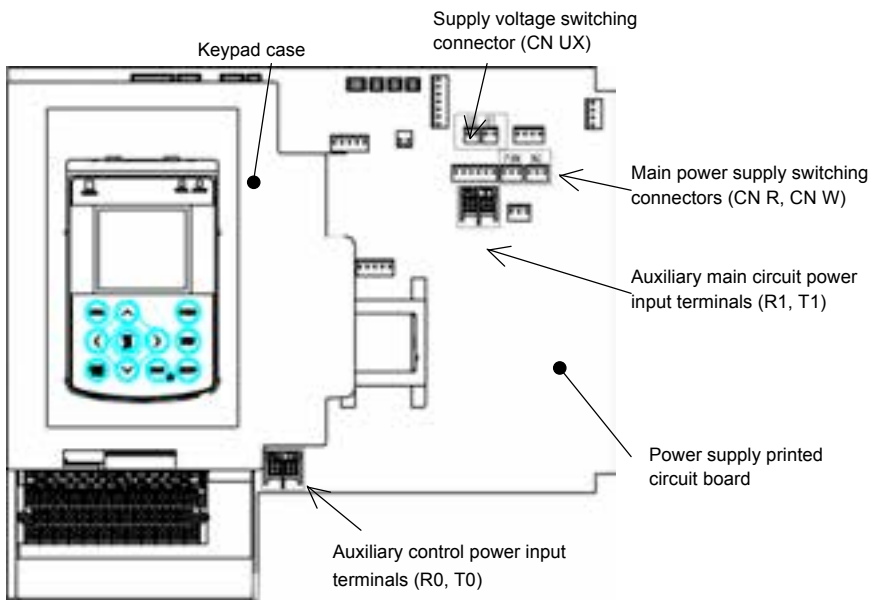
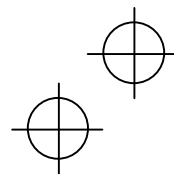
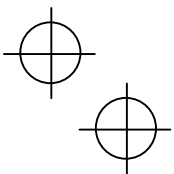

Figure 2.6 Switching Connector Locations
(200 V class series inverters of 55 to 90 kW and 400 V ones of 110 to 132 kW)



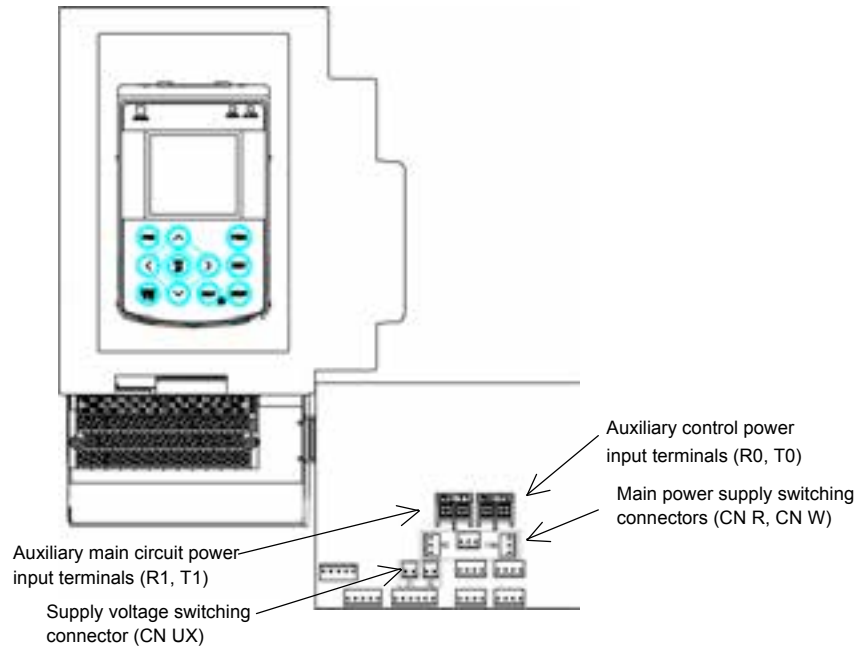
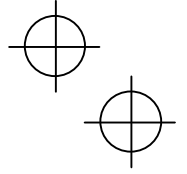
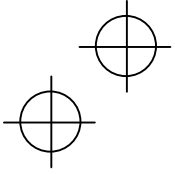
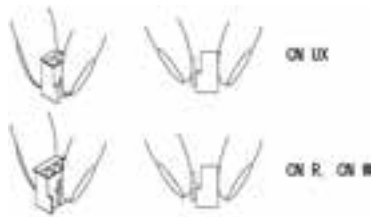

Figure 2.7 Switching Connector Locations (400 V class series inverters of 160 kW or above)



Note

To remove a connector, squeeze the top of the latch between your fingers to release the fastener and pull off the connector. To attach a connector, push it until it makes a clicking sound to ensure that the fastener is securely seated.

Figure 2.8 Attaching and Removing a Switching Connector
(200 V class series inverters of 22 kW or above and 400 V ones of 45 kW or above)

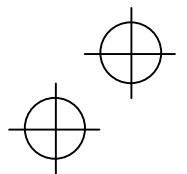
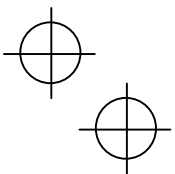

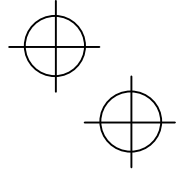
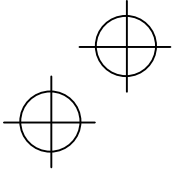

2.2.7 Setting the switches

Switching the slide switches located on the control PCB (see Figure 2.9) allows you to customize the operation mode of the analog output terminals, digital I/O terminals, and communications ports.

To access the slide switches, remove the front cover so that you can see the control PCB.

For details on how to remove the front cover, refer to Section 2.2.1.

Table 2.6 lists function of each slide switch.

Table 2.6 Function of Slide Switches

Switch	Function
SW1	Switches the service mode of the digital input terminals between SINK and SOURCE.
SW2	Switches the terminating resistor of RS-485 communications port on the inverter ON and OFF. (RS-485 communications port 2 on the terminal block)
SW3	Switches the terminating resistor of RS-485 communications port on the inverter ON and OFF. (RS-485 communications port 1 for connecting the keypad)
SW4	Switches the function of terminal [FM1] between VO1 and IO1.
SW5	Switches the function of terminal [C1] between C1 and PTC.
SW6	Switches the function of terminal [FM2] between VO2 and IO2.

Figure 2.9 shows the location of slide switches on the control PCB.





Switch configuration and factory default

	SW1	SW2	SW3	SW4	SW5	SW6
Shipping destination FRN___AQ1■*A	SINK ↓	OFF ↑	OFF ←	VO1 ↑	C1 ↑	VO2 ↑
FRN___AQ1■*E	SOURCE ↑					

Note: ■ is replaced by the corresponding letter of the alphabet depicting the enclosure.
 ■ Enclosure: S (IP00), M (IP21), or L (IP55)
 The asterisk * is replaced by a value indicating the corresponding power supply voltage. (2: three-phase 200 V, 4: three-phase 400 V)

Figure 2.9 Location of the Slide Switches on the Control PCB

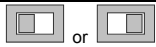
To move a switch slider, use a tool with a narrow tip (e.g., a tip of tweezers). Be careful not to touch other electronic parts, etc. If the slider is in an ambiguous position, the circuit is unclear whether it is turned ON or OFF and the digital input remains in an undefined state. Be sure to place the slider so that it contacts either side of the switch.

Slider in the correct position	
Slider in an ambiguous position	

2.2.8 Mounting and connecting the keypad to the panel

You can remove the keypad from the inverter unit to mount it on the panel or install it at a remote site (e.g., for operation on hand). Note that the inverter with the keypad removed is rated IP00.

For detailed instructions on how to mount the keypad on the panel, refer to the FRENIC-AQUA User's Manual, Chapter 5, Section 5.2 "Mounting and Connecting a Keypad to the Panel."

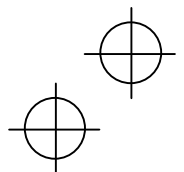
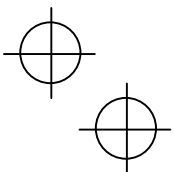

Chapter 3 NAMES AND FUNCTIONS OF KEYPAD COMPONENTS

1 LED Indicators

These indicators show the current running status of the inverter.

STATUS (green): Running state

WARN. (yellow): Light alarm state

ALARM (red): Alarm (heavy alarm) state

2 LCD Monitor

This monitor shows the following various information about the inverter according to the operation modes.

- Running status and run command source (e.g., Run/stop and rotation direction)
- Status icons (e.g., timer operation, PID operation, battery state, and password protection state)
- Operation guides for the current screen

3 Programming Keys

These keys are used to:

- Switch the operation modes between Running mode/Alarm mode and Programming mode.
- Reset the alarm states, discard the setting being configured, and cancel the screen transition according to the operation modes.
- Move the cursor to the digit of data to be modified, shift the setting item, and switch the screen.
- Call up the HELP screen for the current display state.

4 Operation Keys

These keys are used to:

- Start running the motor (in the forward/reverse direction).
- Stop the motor.

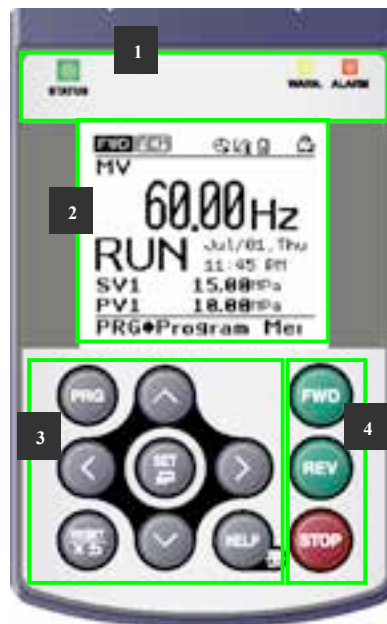

Chapter 4 RUNNING THE MOTOR FOR A TEST

4.1 Checking Prior to Powering ON

Check the following before powering on the inverter.

- (1) Check that the wiring is correct.
Especially check the wiring to the inverter input terminals L1/R, L2/S and L3/T and output terminals U, V, and W. Also check that the grounding wires are connected to the grounding terminals (G) correctly. See Figure 4.1.
- (2) Check the control circuit terminals and main circuit terminals for short circuits or ground faults.
- (3) Check for loose terminals, connectors and screws.
- (4) Check that the motor is separated from mechanical equipment.
- (5) Make sure that all switches of devices connected to the inverter are turned OFF. Powering on the inverter with any of those switches being ON may cause an unexpected motor operation.
- (6) Check that safety measures are taken against runaway of the equipment, e.g., a defense to prevent people from access to the equipment.

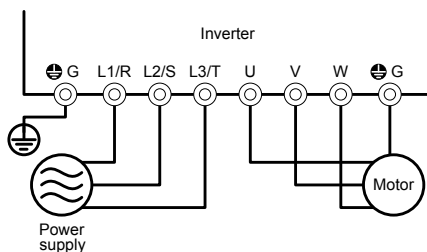

Figure 4.1 Connection of Main Circuit Terminals

4.2 Powering ON and Checking

Turn the power ON and check the following points. The following is a case when no function code data is changed from the factory defaults.

Check that the LCD monitor displays 0.00 Hz (indicating that the reference frequency is 0 Hz) that is blinking. (See Figure 4.2.)



If the LCD monitor displays any number except 0.00 Hz, press the  /  key to set 0.00 Hz.



Figure 4.2 Display of the LCD Monitor after Power-ON



The reactor in the inverter may generate noise due to source voltage distortion, which is not abnormal.

4.3 Configuring the Function Code Data Before Test Run

Configure the function codes listed below according to the motor ratings and your machinery design values. For the motor ratings, check the ratings printed on the motor's nameplate. For your machinery design values, ask system designers about them.

Table 4.1 Configuring Function Code Data





Function code	Name	Function code data	Factory defaults
F04	Base frequency 1	Motor ratings (printed on the nameplate of the motor)	200/400 V class series Asia: 60.0/50.0(Hz) EU: 50.0/50.0(Hz)
F05	Rated voltage at base frequency 1		Asia: 220/415 (V) EU: 230/400 (V)
P02	Motor 1 (Rated capacity)		Nominal applied motor capacity
P03	Motor 1 (Rated current)		Rated current of nominal applied motor
P99	Motor 1 selection		Asia/EU: 0
F03	Maximum frequency 1	Machinery design values (Note) For a test run of the motor, increase values so that they are longer than your machinery design values. If the specified time is short, the inverter may not run the motor properly.	200/400 V class series Asia: 60.0/50.0(Hz) EU: 50.0/50.0(Hz)
F07	Acceleration time 1 (Note)		20.00 (s)
F08	Deceleration time 1 (Note)		20.00 (s)

 For details about the configuration procedure of function codes, refer to the FRENIC-AQUA User's Manual, Chapter 5, Section 5.6.3.1 "Configuring function codes."

4.4 Running the Inverter for Motor Operation Check



After completion of preparations for a test run as described above, start running the inverter for motor operation check using the following procedure.

----- Test Run Procedure -----

- (1) Turn the power ON and check that the reference frequency 0.00 Hz is blinking on the LCD monitor.
- (2) Set a low reference frequency such as 5 Hz, using  /  keys. (Check that the frequency is blinking on the LCD monitor.)
- (3) Press the  key to start running the motor in the forward direction. (Check that the reference frequency is blinking on the LCD monitor.)
- (4) To stop the motor, press the  key.

< Check points during a test run >

- Check that the motor is running in the forward direction.
- Check for smooth rotation without motor humming or excessive vibration.
- Check for smooth acceleration and deceleration.

When no abnormality is found, press the  key again to start driving the motor, then increase the reference frequency using  /  keys. Check the above points again.





< Modification of motor control function code data >

Modifying the current function code data sometimes can solve an insufficient torque or overcurrent incident. The table below lists the major function codes to be accessed. For details, refer to the FRENIC- AQUA User's Manual, Chapter 6 "FUNCTION CODES" or Chapter 9 "TROUBLESHOOTING"

Function code	Name	Modification key points
F07	Acceleration Time 1	If the current limiter is activated due to a short acceleration time and large drive current, prolong the acceleration time.
F08	Deceleration Time 1	If an overvoltage trip occurs due to a short deceleration time, prolong the deceleration time.
F09	Torque Boost 1	If the starting motor torque is deficient, increase the torque boost. If the motor with no load is overexcited, decrease the torque boost.

< Remedy to be taken if an alarm ECF (Enable circuit failure) occurs >

Possible Causes	What to Check and Suggested Measures
(1) Poor connection of interface PCB	Check that the interface printed circuit board (PCB) is firmly connected to the inverter unit. Restarting the inverter releases the alarm.
(2) Enable circuit logic error	Check that the logic states of the output of safety switches match with each other (EN1/EN2 = High/High or Low/Low). Restarting the inverter releases the alarm.
(3) Enable circuit (safety circuit) failure detected	If this error persists after the above procedures have been taken, the inverter is defective. Consult your Fuji Electric representative. (The alarm cannot be released.)

4.5 Preparation for Practical Operation

After verifying normal motor running with the inverter in a test run, proceed to the practical operation.

For details, refer to the FRENIC-AQUA User's Manual.

Chapter 5 TROUBLESHOOTING

5.1 Alarm Codes

Table 5.1 Quick List of Alarm Codes

Code	Name	Description
OC1 OC2 OC3	Instantaneous overcurrent	The inverter momentary output current exceeded the overcurrent level. OC1: Overcurrent during acceleration OC2: Overcurrent during deceleration OC3: Overcurrent during running at a constant speed
EF	Ground fault	A ground-fault current flowed from the inverter's output terminals. (on 200V class series inverter of 22kW or above and 400V ones of 45kW or above)
OV1 OV2 OV3	Overvoltage	The DC link bus voltage exceeded the overvoltage detection level. OV1: Overvoltage during acceleration OV2: Overvoltage during deceleration OV3: Overvoltage during running at a constant speed
LV	Undervoltage	The DC link bus voltage dropped below the undervoltage detection level.
Lin	Input phase loss	An input phase loss occurred or the Interphase voltage unbalance rate was large.
OPL	Output phase loss	An output phase loss occurred.
OH1	Heat sink overheat	The temperature around the heat sink has risen abnormally.
OH2	External alarm	The external alarm THR was entered. (when the THR "Enable external alarm trip" has been assigned to any digital input terminal)
OH3	Inverter internal overheat	The temperature inside the inverter has exceeded the allowable limit.
OH4	Motor protection (PTC thermistor)	The temperature of the motor has risen abnormally.
FUS	Fuse trip	An internal short-circuit tripped a fuse (on 200V class series inverter of 90kW or above and 400V ones of 110kW or above)
PbF	Charging circuit malfunction	No power was supplied to the charging resistance short-circuit electromagnetic contactor (on 200V class series inverter of 22kW or above and 400V ones of 45kW or above).
OL1	Overload of motor 1	The electronic thermal protection for motor overload detection was activated.
OLU	Inverter overload	The temperature inside the inverter has risen abnormally.
Er1	Memory error	An error has occurred in writing data to the memory in the inverter.
Er2	Keypad communications error	A communications error has occurred between the keypad and the inverter.
Er3	CPU error	A CPU error or LSI error has occurred.
Er4	Option communications error	A communications error has occurred between the connected option card and the inverter.
Er5	Option error	An error was detected by the connected option card (not by the inverter).
Er6	Operation protection	An incorrect operation was attempted.
Er7	Tuning error	Auto-tuning has failed, resulting in abnormal tuning results.
Er8 ErP	RS-485 communications error (COM port 1) RS-485 communications error (COM port 2)	A communications error has occurred during RS-485 communication.
ErF	Data saving error during undervoltage	When the undervoltage protection was activated, the inverter failed to save data, showing this error.
ErH	Hardware error	The LSI on the power printed circuit board has malfunctioned due to noise, etc.

Table 5.1 Quick List of Alarm Codes (Continued)

Code	Name	Description
PV1 PV2 PVA PVb PVC	PID feedback error	The PID feedback signal wire is broken under PID control.
CoF	Current input break detection	A break was detected in the current input.
ECF	Enable circuit failure	The Enable circuit was diagnosed as a circuit failure.
ECL	Customizable logic error	A customizable logic configuration error has caused an alarm.
Pdr	Drought protection	A droughty state was detected under PID control.
roC	Control of maximum start per hour	Problem A PID control insufficient water stoppage occurred frequently.
PoL	End of curve protection	Problem A large water quantity condition was detected during PID control.
rLo	Stuck prevention	The inverter failed to start due to overcurrent.
FoL	Filter clogging error	An overload state was detected under PID control.
LoK	Password protection	A wrong password has been entered exceeding the predetermined number of times.
Err	Mock alarm	A mock alarm has been generated intentionally by configuring H45 or keypad operation.

Chapter 6 MAINTENANCE AND INSPECTION

Perform daily and periodic inspections to avoid trouble and keep reliable operation of the inverter for a long time.

6.1 Daily Inspection

Visually inspect the inverter for operation errors from the outside without removing the covers when the inverter is ON or operating.

- Check that the expected performance (satisfying the standard specifications) is obtained.
- Check that the surrounding environment satisfies the environmental requirements given in Chapter 1, Section 1.3.1 "Usage environment."
- Check that the keypad displays normally.
- Check for abnormal noise, odor, or excessive vibration.
- Check for traces of overheat, discoloration and other defects.

6.2 Periodic Inspection

Before starting periodic inspections, be sure to stop the motor, shut down the power, and wait at least 10 minutes. Make sure that the charging lamp is turned OFF. Further, make sure, using a multimeter or a similar instrument, that the DC link bus voltage between the main circuit terminals P(+) and N(-) has dropped to the safe level (+25 VDC or below).

Table 6.1 List of Periodic Inspections

Check part	Check item	How to inspect	Evaluation criteria
Environment	1) Check the ambient temperature, humidity, vibration and atmosphere (dust, gas, oil mist, or water drops). 2) Check that tools or other foreign materials or dangerous objects are not left around the equipment.	1) Check visually or measure using apparatus. 2) Visual inspection	1) The standard specifications must be satisfied. 2) No foreign or dangerous objects are left.
Input voltage	Check that the input voltages of the main and control circuit are correct.	Measure the input voltages using a multimeter or the like.	The standard specifications must be satisfied.
Keypad	1) Check that the display is clear. 2) Check that there is no missing part in the displayed characters.	1), 2) Visual inspection	1), 2) The display can be read and there is no fault.
Structure such as frame and cover	Check for: 1) Abnormal noise or excessive vibration 2) Loose bolts (at clamp sections). 3) Deformation and breakage 4) Discoloration caused by overheat 5) Contamination and accumulation of dust or dirt	1) Visual or auditory inspection 2) Retighten. 3), 4), 5) Visual inspection	1), 2), 3), 4), 5) No abnormalities
Main circuit	Common	1) Retighten. 2), 3) Visual inspection	1), 2), 3) No abnormalities
	Conductors and wires	1), 2) Visual inspection	1), 2) No abnormalities

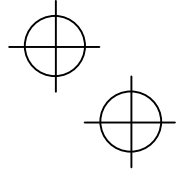
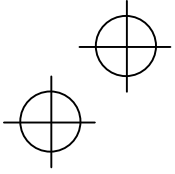

	Terminal blocks	Check that the terminal blocks are not damaged.	Visual inspection	No abnormalities
--	-----------------	---	-------------------	------------------

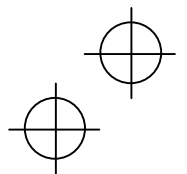
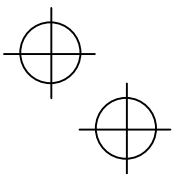

Table 6.1 List of Periodic Inspections (Continued)

Check part	Check item	How to inspect	Evaluation criteria
Main circuit	DC link bus capacitor	1), 2) Visual inspection 3) Measure the discharge time with capacitance probe.	1), 2) No abnormalities 3) The discharge time should not be shorter than the one specified by the replacement manual.
	Transformer and reactor	Check for abnormal roaring noise and odor.	Auditory, visual, and olfactory inspection No abnormalities
	Magnetic contactor and relay	1) Check for chatters during operation. 2) Check that contact surface is not rough.	1) Auditory inspection 2) Visual inspection 1), 2) No abnormalities
Control circuit	Printed circuit board	1) Check for loose screws and connectors. 2) Check for odor and discoloration. 3) Check for cracks, breakage, deformation and rust. 4) Check the capacitors for electrolyte leaks and deformation.	1) Retighten. 2) Olfactory and visual inspection 3), 4) Visual inspection 1), 2), 3), 4) No abnormalities
Cooling system	Cooling fan	1) Check for abnormal noise and excessive vibration. 2) Check for loose bolts. 3) Check for discoloration caused by overheat.	1) Auditory and visual inspection, or turn manually (be sure to turn the power OFF). 2) Retighten. 3) Visual inspection 1) Smooth rotation 2), 3) No abnormalities
	Ventilation path	Check the heat sink, intake and exhaust ports for clogging and foreign materials.	Visual inspection No abnormalities

Remove dust accumulating on the inverter with a vacuum cleaner. If the inverter is stained, wipe it off with a chemically neutral cloth.

6.3 List of Periodic Replacement Parts

The inverter consists of many electronic parts including semiconductor devices. Table 6.2 lists replacement parts that should be periodically replaced for preventive maintenance (Use the lifetime judgment function as a guide). These parts are likely to deteriorate with age due to their construction and properties, leading to the decreased performance or failure of the inverter.

When the replacement is necessary, consult your Fuji Electric representative.

Table 6.2 Replacement Parts

Part name	Standard replacement intervals (See Notes below.)	
	200Vclass series 0.75 to 45 kW 400Vclass series 0.75 to 90kW	200Vclass series 55 to 90 kW 400Vclass series 110 to 710kW
DC link bus capacitor	5 years	10 years
Electrolytic capacitors on printed circuit boards	5 years	10 years
Cooling fans	5 years	10 years
Fuse	-	10 years

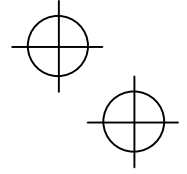
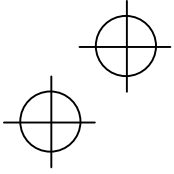

(Notes) • These replacement intervals are based on the inverter's service life estimated at an ambient temperature of 30 °C (AQ1L) or 40 °C (AQ1M/AQ1S), and with a load factor of 100% (AQ1L/AQ1M) or 80% (AQ1S). Replacement intervals may be shorter when the ambient temperature exceeds 30 °C (AQ1L) or 40 °C (AQ1M/AQ1S), or when the inverter is used in an excessively dusty environment.

• Standard replacement intervals mentioned above are only a guide for replacement, and not a guaranteed service life.

6.4 Inquiries about Product and Guarantee

6.4.1 When making an inquiry

Upon breakage of the product, uncertainties, failure or inquiries, inform your Fuji Electric representative of the following information.

- 1) Inverter type (Refer to Chapter 1, Section 1.1.)
- 2) SER No. (serial number of the product) (Refer to Chapter 1, Section 1.1.)
- 3) Function codes and their data that you changed (Refer to the FRENIC-AQUA User's Manual, Chapter 5, Section 5.6.3.2.)
- 4) ROM version (Refer to FRENIC-AQUA User's Manual, Chapter 5, Section 5.6.4.4.)
- 5) Date of purchase
- 6) Inquiries (for example, point and extent of breakage, uncertainties, failure phenomena and other circumstances)

6.4.2 Product warranty

To all our customers who purchase Fuji Electric products included in this documentation:

Please take the following items into consideration when placing your order.

When requesting an estimate and placing your orders for the products included in these materials, please be aware that any items such as specifications which are not specifically mentioned in the contract, catalog, specifications or other materials will be as mentioned below.

In addition, the products included in these materials are limited in the use they are put to and the place where they can be used, etc., and may require periodic inspection. Please confirm these points with your sales representative or directly with this company.

Furthermore, regarding purchased products and delivered products, we request that you inspect the product at the time of delivery. Also, prepare the area for installation of the inverter.

[1] Free of charge warranty period and warranty range

(1) Free of charge warranty period

- 1) The product warranty period is "1 year from the date of purchase" or 24 months from the manufacturing date imprinted on the name place, whichever date is earlier.
- 2) However, in cases where the installation environment, conditions of use, frequency or use and times used, etc., have an effect on product life, this warranty period may not apply.
- 3) Furthermore, the warranty period for parts repaired by Fuji Electric's Service Department is "6 months from the date that repairs are completed."

(2) Warranty range

- 1) In the event that breakdown occurs during the product's warranty period which is the responsibility of Fuji Electric, Fuji Electric will replace or repair the part of the product that has broken down free of charge at the place where the product was purchased or where it was delivered. However, if the following cases are applicable, the terms of this warranty may not apply.

❶ The breakdown was caused by the installation conditions, environment, handling or methods of use, etc. which are not specified in the catalog, operation manual, specifications or other relevant documents.

❷ The breakdown was caused by the product other than the purchased or delivered Fuji's product.

❸ The breakdown was caused by the product other than Fuji's product, such as the customer's equipment or software design, etc.

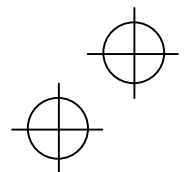
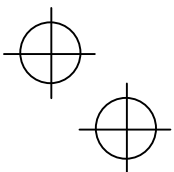

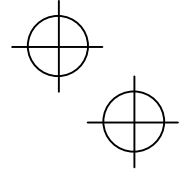
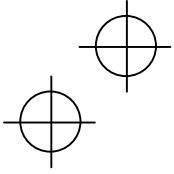

- ④ Concerning the Fuji's programmable products, the breakdown was caused by a program other than a program supplied by this company, or the results from using such a program.
- ⑤ The breakdown was caused by modifications or repairs affected by a party other than Fuji Electric.
- ⑥ The breakdown was caused by improper maintenance or replacement of replaceable items, etc. specified in the operation manual or catalog, etc.
- ⑦ The breakdown was caused by a science or technical or other problem that was not foreseen when making practical application of the product at the time it was purchased or delivered.
- ⑧ The product was not used in the manner the product was originally intended to be used.
- ⑨ The breakdown was caused by a reason which Fuji Electric is not responsible, such as lightning or other disaster.

- 2) Furthermore, the warranty specified herein shall be limited to the purchased or delivered product alone.
- 3) The upper limit for the warranty range shall be as specified in item (1) above and any damages (damage to or loss of machinery or equipment, or lost profits from the same, etc.) consequent to or resulting from breakdown of the purchased or delivered product shall be excluded from coverage by this warranty.

(3) Trouble diagnosis

As a rule, the customer is requested to carry out a preliminary trouble diagnosis. However, at the customer's request, this company or its service network can perform the trouble diagnosis on a chargeable basis. In this case, the customer is asked to assume the burden for charges levied in accordance with this company's fee schedule.

[2] Exclusion of liability for loss of opportunity, etc.

Regardless of whether a breakdown occurs during or after the free of charge warranty period, this company shall not be liable for any loss of opportunity, loss of profits, or damages arising from special circumstances, secondary damages, accident compensation to another company, or damages to products other than this company's products, whether foreseen or not by this company, which this company is not be responsible for causing.

[3] Repair period after production stop, spare parts supply period (holding period)

Concerning models (products) which have gone out of production, this company will perform repairs for a period of 7 years after production stop, counting from the month and year when the production stop occurs. In addition, we will continue to supply the spare parts required for repairs for a period of 7 years, counting from the month and year when the production stop occurs. However, if it is estimated that the life cycle of certain electronic and other parts is short and it will be difficult to procure or produce those parts, there may be cases where it is difficult to provide repairs or supply spare parts even within this 7-year period. For details, please confirm at our company's business office or our service office.

[4] Transfer rights

In the case of standard products which do not include settings or adjustments in an application program, the products shall be transported to and transferred to the customer and this company shall not be responsible for local adjustments or trial operation.

[5] Service contents

The cost of purchased and delivered products does not include the cost of dispatching engineers or service costs. Depending on the request, these can be discussed separately.

[6] Applicable scope of service

Above contents shall be assumed to apply to transactions and use in the country where you purchased the products.

Consult your local supplier or Fuji Electric representative for details.

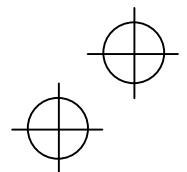
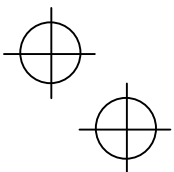

Chapter 7 SPECIFICATIONS

7.1 Standard Model

Three-phase 200 V class series

(0.75 to 90kW)

Item		Specifications																	
Type (FRN_ _ _AQ1■-2□) (*1)		0.75	1.5	2.2	3.7 (4.0) (*10)	5.5	7.5	11	15	18.5	22	30	37	45	55	75	90		
Nominal applied motor (kW) (*2) (Rated output)		0.75	1.5	2.2	3.7 (4.0) (*10)	5.5	7.5	11	15	18.5	22	30	37	45	55	75	90		
Output Ratings	Rated capacity (kVA) (*3)	1.9	3.0	4.1	6.8	10	12	17	22	28	33	43	55	68	81	107	131		
	Voltage (V) (*4)	Three-phase, 200 to 240 V (with AVR function)										Three-phase, 200 to 230 V (with AVR function)							
	Rated current (A) (*5)	5	8	11	18	27	31.8	46.2	59.4	74.8	88	115	146	180	215	283	346		
Overload capability		110%-1 min (Overload interval: Compliant with IEC 61800-2)																	
Input power	Main power supply (number of phases, voltage, frequency)	Three-phase, 200 to 240 V, 50/60 Hz										Three-phase, 200 to 220 V, 50 Hz Three-phase, 200 to 230 V, 60 Hz							
	Auxiliary control power supply (number of phases, voltage, frequency)	Single-phase, 200 to 240 V, 50/60 Hz										Single-phase, 200 to 230 V, 50/60 Hz							
	Auxiliary main power supply (number of phases, voltage, frequency) (*6)	-										Single -phase, 200 to 220 V, 50 Hz Single -phase, 200 to 230 V, 60 Hz							
	Allowable voltage/frequency	Voltage: +10 to -15% (Interphase voltage unbalance: 2% or less) (*11), Frequency: +5 to -5%																	
	Rated current (A) (*7)	3.2	6.0	8.6	14.8	20.6	27.8	41.4	55.8	69.0	82.2	112	139	167	203	282	334		
Required capacity (kVA)	1.2	2.1	3.0	5.2	7.2	9.7	15	20	24	29	39	49	58	71	98	116			
Braking	Braking torque [%] (*8)	20										10 to 15							
	DC braking	Braking start frequency: 0.0 to 60.0 Hz; Braking time: 0.0 to 30.0 s; Braking operation level: 0 to 60%																	
EMC filter (IEC/EN 61800-3: 2004)		EMC standards compliance : Category C2 (emission) / 2nd Env. (Immunity)														C3/2nd			
DC reactor (DCR) (*9)		Built-in(IEC/EN 61000-3-2, IEC/EN 61000-3-12)														Standard accessory (IEC/EN 61000-3-12)			
Power factor (at the rated load)	Fundamental wave power factor	> 0.98																	
	Total power factor	≥ 0.90																	
Efficiency (at the rated load) (%)		97	97	97	97	97	98	98	98	98	98	98	98	98	98	98	98		
Applicable (safety) standards		UL 508C, C22.2 No. 14, IEC/EN 61800-5-1:2007, SEMI F47-0706																	
Enclosure	IEC/EN 60529	IP21/IP55 (*12)														IP00			
	UL 50	UL TYPE 1/ UL TYPE 12														UL open type			
Cooling method		Fan cooling																	
Weight / Mass (kg)	IP21	10	10	10	10	18	18	18	23	23	50	50	70	70	-	-	-		
	IP55	10	10	10	10	18	18	18	23	23	50	50	70	70	-	-	-		
	IP00	-	-	-	-	-	-	-	-	-	-	-	-	-	-	42	43	62	

(*1) A box (■) replaces an alphabetic letter depending on the enclosure. A box (□) replaces an alphabetic letter depending on the shipping destination.

■Enclosure: M (IP21), L (IP55) or S (IP00) □Shipping destination: E (Europe) or, A (Asia)

(*2) Fuji 4-pole standard motor

(*3) Applies to inverters with a rated capacity of 220 V.

(*4) The inverter cannot output a voltage higher than the supply voltage.

(*5) When running the inverter at the carrier frequency 4 kHz or above, it is necessary to derate the current rating.

(*6) If using inverters with DC power input, supply AC power to the internal circuits. Inverters with DC power input are not normally used.

(*7) When the inverter is connected to the power supply of 200 V, 50 Hz, Rsc = 120.

(*8) Indicates average braking torque value for motor alone (varies with motor efficiency).

(*9) Inverters of 45kW or less are equipped with a built-in DC reactor (DCR). An external DCR is provided as standard for inverters of 55kW and above.

(*10) 4.0 kW for the EU.

(*11) Voltage unbalance [%] = (Max. voltage [V] - Min. voltage [V])/Three-phase average voltage [V] x 67 (See IEC/EN 61800-3.)

If this value is 2 to 3%, use an optional AC reactor (ACR). *Applies to all models, regardless of capacity.

Even if the voltage drops down to -20%, the inverter can run (operation guaranteed) provided that the load current is within the inverter rated current range. *Applies only to models with a capacity of 37 kW or less.

(*12) IP55 offers protection for short water jets. Do not use outdoors or in places where long-term waterproofing is required.

**Three-phase 400 V class series
(0.75 to 37 kW)**

Item		Specifications											
Type (FRN <input type="checkbox"/> AQ1 <input type="checkbox"/> 4□) (*1)		0.75	1.5	2.2	3.7 (4.0) ^(*10)	5.5	7.5	11	15	18.5	22	30	37
Nominal applied motor (kW) (*2) (Rated output)		0.75	1.5	2.2	3.7 (4.0) ^(*10)	5.5	7.5	11	15	18.5	22	30	37
Output ratings	Rated capacity (kVA) (*3)	1.9	3.1	4.1	6.8	10	14	18	24	29	34	45	57
	Voltage (V) (*4)	Three-phase, 380 to 480 V (with AVR function)											
	Rated current (A) (*5)	2.5	4.1	5.5	9.0	13.5	18.5	24.5	32	39	45	60	75
Input power	Overload capability	110%-1 min (Overload interval: Compliant with IEC 61800-2)											
	Main power supply (number of phases, voltage, frequency)	Three-phase, 380 to 480 V, 50/60 Hz											
	Auxiliary control power supply (number of phases, voltage, frequency)	Single-phase, 380 to 480 V, 50/60 Hz											
	Allowable voltage/frequency	Voltage: +10 to -15% (Interphase voltage unbalance: 2% or less) (*11), Frequency: +5 to -5%											
Braking	Rated current (A) (*7)	1.6	3.0	4.3	7.4	10.3	13.9	20.7	27.9	34.5	41.1	55.7	69.4
	Required capacity (kVA)	1.2	2.1	3.0	5.2	7.2	9.7	15	20	24	29	39	49
Braking	Braking torque [%] (*8)	20											
	DC braking	Braking start frequency: 0.0 to 60.0 Hz; Braking time: 0.0 to 30.0 s; Braking operation level: 0 to 60%											
EMC filter (IEC/EN 61800-3: 2004)		EMC standards compliance : Category C2 (emission) / 2nd Env. (Immunity)											
DC reactor (DCR) (*9)		Built-in (IEC/EN 61000-3-2, IEC/EN 61000-3-12)											
Power factor (at the rated load)	Fundamental wave power factor	> 0.98											
	Total power factor	≥ 0.90											
Efficiency (at the rated load) (%)		95	96	97	97	97	97	97	97	98	98	98	98
Applicable (safety) standards		UL 508C, C22.2 No. 14, IEC/EN 61800-5-1:2007, SEMI F47-0706											
Enclosure	IEC/EN 60529	IP21/IP55 (*12),											
	UL 50	UL TYPE 1/ UL TYPE 12											
Cooling method		Fan cooling											
Weight / Mass (kg)	IP21	10	10	10	10	10	10	18	18	18	18	23	23
	IP55	10	10	10	10	10	10	18	18	18	18	23	23

(*1) A box (■) replaces an alphabetic letter depending on the enclosure.

A box (□) replaces an alphabetic letter depending on the shipping destination.

■ Enclosure: M (IP21), L (IP55) or S (IP00) □ Shipping destination: E (Europe) or A (Asia)

(*2) Fuji 4-pole standard motor

(*3) Applies to inverters with a rated capacity of 440 V.

(*4) The inverter cannot output a voltage higher than the supply voltage.

(*5) When running the inverter at the carrier frequency 4 kHz or above, it is necessary to derate the current rating.

(*7) When the inverter is connected to the power supply of 400 V, 50 Hz, Rsce = 120.

(*8) Indicates average braking torque value for motor alone (varies with motor efficiency).

(*9) Inverters in this class are equipped with a built-in DC reactor (DCR).

(*10) 4.0 kW for the EU.

(*11) Voltage unbalance [%] = (Max. voltage [V] - Min. voltage [V])/Three-phase average voltage [V] x 67 (See IEC/EN61800-3.)

If this value is 2 to 3%, use an optional AC reactor (ACR). *Applies to all models, regardless of capacity.

Even if the voltage drops down to -20%, the inverter can run (operation guaranteed) provided that the load current is within the inverter rated current range. *Applies only to models with a capacity of 37 kW or less.

(*12) IP55 offers protection for short water jets. Do not use outdoors or in places where long-term waterproofing is required.

(45 to 710 kW)

Item		Specifications															
Type (FRN AQ1■-4□) (*1)		45	55	75	90	110	132	160	200	220	280	315	355	400	500	630	710
Nominal applied motor (kW) (*2) (Rated output)		45	55	75	90	110	132	160	200	220	280	315	355	400	500	630	710
Output ratings	Rated capacity (kVA) (*3)	69	85	114	134	160	192	231	287	316	396	445	495	563	731	891	1044
	Voltage (V) (*4)	Three-phase, 380 to 480 V (with AVR function)															
	Rated current (A) (*5)	91	112	150	176	210	253	304	377	415	520	585	650	740	960	1170	1370
Input power	Overload capability	110%-1 min (Overload interval: Compliant with IEC 61800-2)															
	Main power supply (number of phases, voltage, frequency)	Three-phase, 380 to 440 V, 50 Hz Three-phase, 380 to 480 V, 60 Hz															
	Auxiliary control power supply (number of phases, voltage, frequency)	Single-phase, 380 to 480 V, 50/60 Hz															
	Auxiliary main power supply (number of phases, voltage, frequency) (*6)	Single-phase, 380 to 440 V, 50 Hz Single-phase, 380 to 480 V, 60 Hz															
	Allowable voltage/frequency	Voltage: +10 to -15% (Interphase voltage unbalance: 2% or less) (**11), Frequency: +5 to -5%															
	Rated current (A) (*7)	83.1	102	136	162	201	238	286	357	390	500	559	628	705	881	1115	1256
Braking	Required capacity (kVA)	58	71	95	113	140	165	199	248	271	347	388	436	489	611	773	871
	Braking torque [%] (*8)	10 to 15															
DC braking	Braking start frequency: 0.0 to 60.0 Hz; Braking time: 0.0 to 30.0 s; Braking operation level: 0 to 60%																
EMC filter (IEC/EN 61800-3: 2004)	C2/2nd		EMC standards compliance : Category C3 (emission) / 2nd Env. (immunity)														
DC reactor (DCR) (*9)	Built-in (IEC/EN 61000-3-2, IEC/EN 61000-3-12)		Standard accessory (IEC/EN 61000-3-12)														
Power factor (at the rated load)	Fundamental wave power factor	> 0.98															
	Total power factor	≥ 0.90															
Efficiency (at the rated load) (%)	98	98	98	98	98	98	98	98	98	98	98	98	98	98	98	98	98
Applicable (safety) standards	UL 508C, C22.2 No. 14, IEC/EN 61800-5-1:2007, SEMI F47-0706																
Enclosure	IEC/EN 60529	IP21/IP55 (*12)					IP00										
	UL 50	UL TYPE 1/UL TYPE 12					UL open type										
Cooling method	Fan cooling																
Weight / Mass (kg)	IP21	50	50	70	70	-											
	IP55	50	50	70	70	-											
	IP00	-	-	-	-	62	64	94	98	129	140	245	245	245	330	530	530

- (*1) A box (■) replaces an alphabetic letter depending on the enclosure.
A box (□) replaces an alphabetic letter depending on the shipping destination.
■Enclosure: M (IP21), L (IP55) or S (IP00) □Shipping destination: E (Europe) or A (Asia)
- (*2) Fuji 4-pole standard motor
- (*3) Applies to inverters with a rated capacity of 440 V.
- (*4) The inverter cannot output a voltage higher than the supply voltage.
- (*5) When running the inverter at the carrier frequency 4 kHz or above (5 kHz or above for inverters of 110 kW or above), it is necessary to derate the current rating.
- (*6) If using inverters with DC power input, supply AC power to the internal circuits. Inverters with DC power input are not normally used.
- (*7) When the inverter is connected to the power supply of 400 V, 50 Hz, R_{sce} = 120.
- (*8) Indicates average braking torque value for motor alone (varies with motor efficiency).
- (*9) Inverters of 90kW or less are equipped with a built-in DC reactor (DCR). An external DCR is provided as standard for inverters of 110kW and above.
- (*11) Voltage unbalance [%] = (Max. voltage [V] - Min. voltage [V])/Three-phase average voltage [V] x 67 (See IEC/EN 61800-3.)
If this value is 2 to 3%, use an optional AC reactor (ACR).
- (*12) IP55 offers protection for short water jets. Do not use outdoors or in places where long-term waterproofing is required.

7.2 External Dimensions

Rated voltage	Inverter type	Refer to:	Dimensions (mm)											
			W	H	D	D1	D2	W1	W2	H1	H2	H3	M	N
Three-phase 200V	FRN0.75AQ1■-2□	Figure 1	150	465	262	162	100	115	17.5	451	7	-	2×φ8	8
	FRN1.5AQ1■-2□													
	FRN2.2AQ1■-2□													
	FRN3.7AQ1■-2□													
	FRN4.0AQ1■-2E*													
	FRN5.5AQ1■-2□													
	FRN7.5AQ1■-2□													
	FRN11AQ1■-2□													
	FRN15AQ1■-2□	203	585	158	22.5	571								
	FRN18.5AQ1■-2□						645	631						
	FRN22AQ1■-2□													
	FRN30AQ1■-2□													
	FRN37AQ1■-2□	Figure 2	265	736	284	184.5			99.5	180	42.5	716	12	8
	FRN45AQ1■-2□													
	FRN55AQ1S-2□													
	FRN75AQ1S-2□	Figure 3	300	885	367.9	240.8	127.1	215	720	15.5	14.5	2×φ15	15	
FRN90AQ1S-2□														
FRN90AQ1S-2□	Figure 4	355	740	270	115	155	275	40	12	8	2×φ10	10		
FRN90AQ1S-2□	Figure 4	530	750	285	145	140	430	50	15.5	14.5	2×φ15	15		
Three-phase 400V	FRN0.75AQ1■-4□	Figure 1	150	465	262	162	100	115	17.5	451	7	-	2×φ8	8
	FRN1.5AQ1■-4□													
	FRN2.2AQ1■-4□													
	FRN3.7AQ1■-4□													
	FRN4.0AQ1■-4E*													
	FRN5.5AQ1■-4□													
	FRN7.5AQ1■-4□													
	FRN11AQ1■-4□													
	FRN15AQ1■-4□	203	585	158	22.5	571								
	FRN18.5AQ1■-4□						645	631						
	FRN22AQ1■-4□													
	FRN30AQ1■-4□													
	FRN37AQ1■-4□	Figure 2	265	736	284	184.5			99.5	180	42.5	716	12	8
	FRN45AQ1■-4□													
	FRN55AQ1■-4□													
	FRN75AQ1■-4□	Figure 3	300	885	367.9	240.8	127.1	215	710	15.5	14.5	2×φ15	15	
	FRN90AQ1■-4□													
	FRN110AQ1S-4□	Figure 4	530	740	315	135	180	430	50	970	15.5	14.5	3×φ15	15
	FRN132AQ1S-4□													
	FRN160AQ1S-4□													
	FRN200AQ1S-4□													
	FRN220AQ1S-4□	Figure 4	680	1000	360	180	180	290	1370	15.5	14.5	3×φ15	15	
	FRN280AQ1S-4□													
	FRN315AQ1S-4□													
FRN355AQ1S-4□														
FRN400AQ1S-4□	Figure 5	880	1400	440	260	260	260	49.5	1520	15.5	14.5	4×φ15	15	
FRN500AQ1S-4□														
FRN630AQ1S-4□														
FRN710AQ1S-4□	Figure 5	1000	1550	500	313.2	186.8	300	49.5	1520	15.5	14.5	4×φ15	15	

* 4.0 kW for the EU. The inverter type is FRN4.0AQ1■-2E or FRN4.0AQ1■-4E.

Note A box (■) replaces an alphabetic letter depending on the enclosure.

A box (□) replaces an alphabetic letter depending on the shipping destination.

■ Enclosure: M (IP21) or L (IP55) □ Shipping destination: E (Europe) or A (Asia)

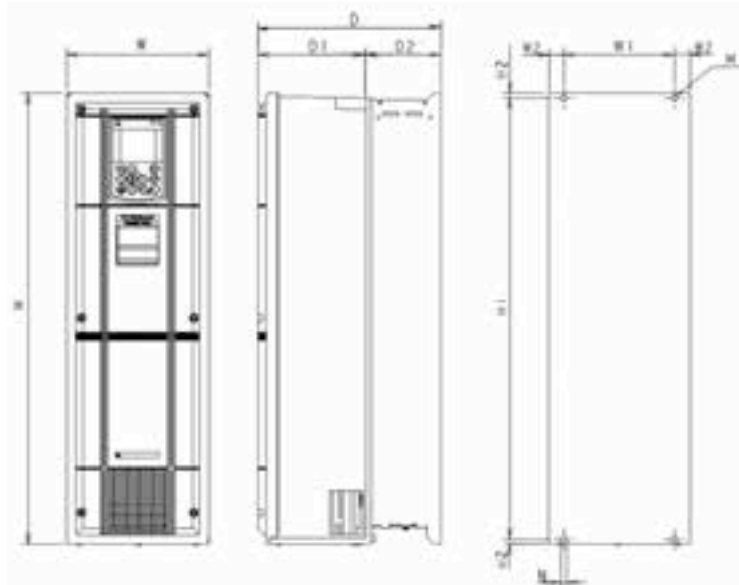
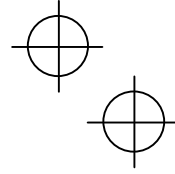
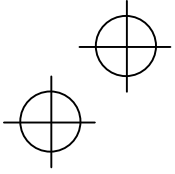

Figure 1 External Dimensions of the Inverter

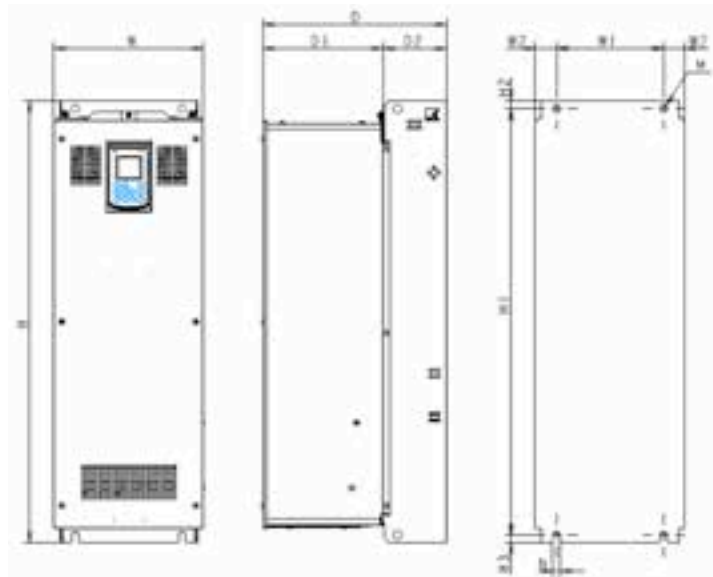
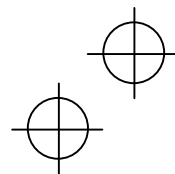
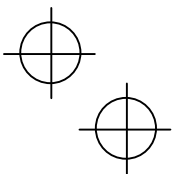

Figure 2 External Dimensions of the Inverter



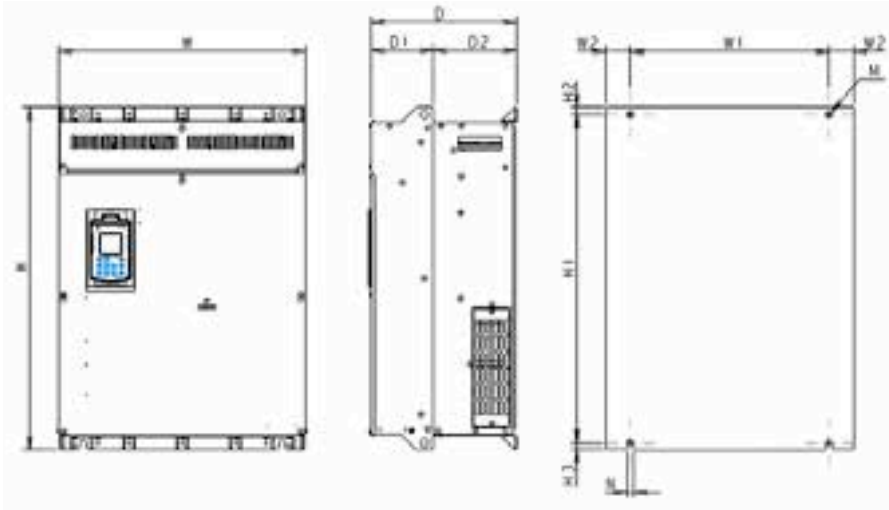
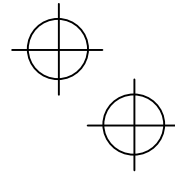
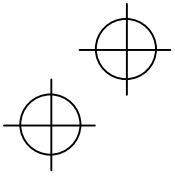

Figure 3 External Dimensions of the Inverter

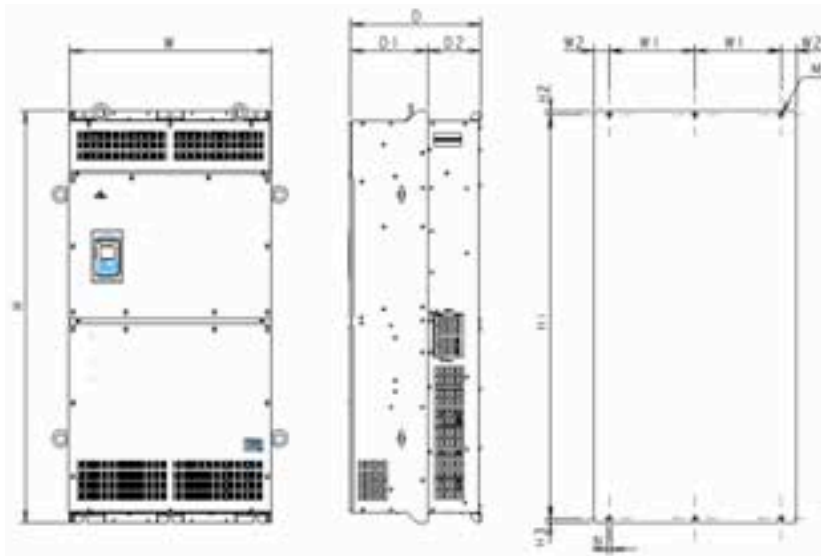
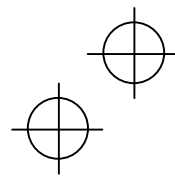
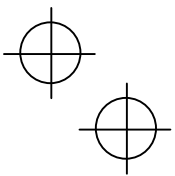

Figure 4 External Dimensions of the Inverter



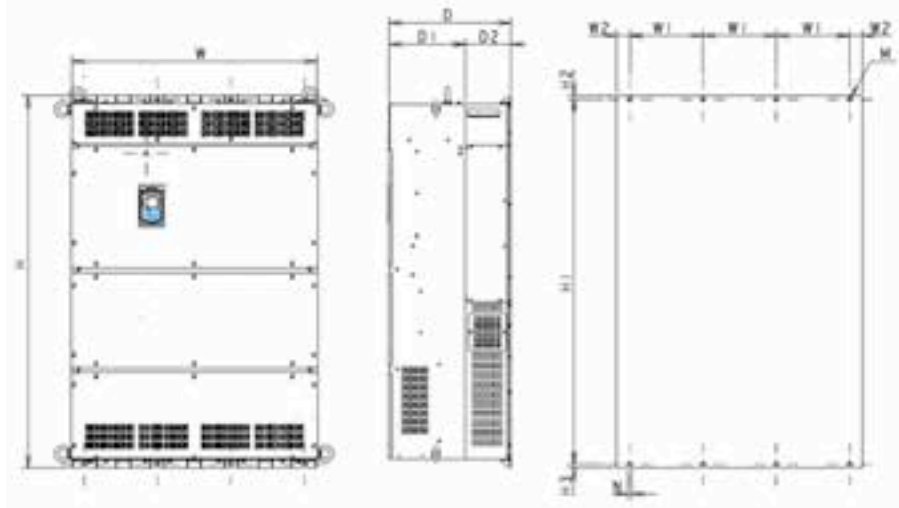
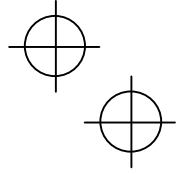
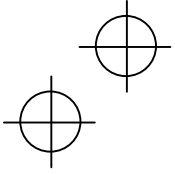
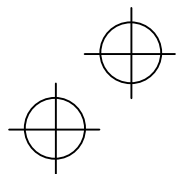
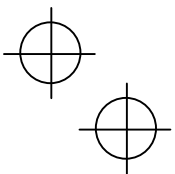

Figure 5 External Dimensions of the Inverter



Chapter 8 CONFORMITY WITH STANDARDS

8.1 Compliance with European Standards

The CE marking on Fuji products indicates that they comply with the essential requirements of the Electromagnetic Compatibility (EMC) Directive 2004/108/EC and Low Voltage Directive 2006/95/EC which are issued by the Council of the European Communities.

Tip By installing an external EMC-compatible filter to the input side for 200 V class series inverters of 55kW or above and 400V ones of 110kW or above, the EMC directive emission category can be changed from C3 to C2.

Refer to "11.1 European Standards Compliance" in Chapter 11 of the FRENIC-AQUA User's Manual for details if installing an external EMC-compatible filter.

Note The amount of current leaked or when an external EMC-compatible filter is installed is significantly large, and therefore a check should be performed to determine whether the power supply system is affected.

Refer to "11.1 European Standards Compliance" in Chapter 11 of the FRENIC-AQUA User's Manual for details on EMC filter leakage current values.

The products comply with the following standards

Table 8.1 Standalone Standard Compliance

	FRN0.75AQ1■-2□ to FRN45AQ1■-2□ FRN0.75AQ1■-4□ to FRN90AQ1■-4□	FRN55AQ1S-2□ to FRN90AQ1S-2□ FRN110AQ1S-4□ to FRN710AQ1S-4□
Low Voltage Directive	IEC/EN 61800-5-1: 2007	
EMC Directives	IEC/EN 61800-3: 2004	
Immunity	Second environment (Industrial)	
Emission	Category C2	Category C3

Table 8.2 Standard Compliance When Used with an EMC Filter

Inverter alone	FRN55AQ1S-2□ to FRN90AQ1S-2□ FRN110AQ1S-4□ to FRN280AQ1S-4□	FRN315AQ1S-4□ to FRN710AQ1S-4□
EMC filter	FS or FN series (optional; see Table 8.4)	
Low Voltage Directive	IEC/EN 61800-5-1: 2007	
EMC Directives	IEC/EN 61800-3: 2004	
Immunity	Second environment (Industrial)	
Emission	Category C2	Category C3

Note A box (■) replaces an alphabetic letter depending on the enclosure.
A box (□) replaces an alphabetic letter depending on the shipping destination.
■Enclosure: M (IP21) or L (IP55) □Shipping destination: E (Europe) or A (Asia)

8.2 Conformity to the Low Voltage Directive in the EU

To use Fuji inverters as a product conforming to the Low Voltage Directive in the EU, refer to guidelines given on pages vi to ix.

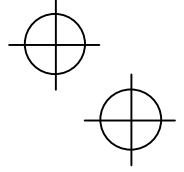
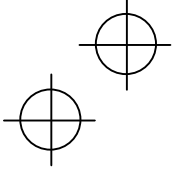

8.3 Compliance with EMC Standards

8.3.1 General

The CE marking on inverters does not ensure that the entire equipment including our CE-marked products is compliant with the EMC Directive. Therefore, CE marking for the equipment shall be the responsibility of the equipment manufacturer. For this reason, Fuji's CE mark is indicated under the condition that the product shall be used within equipment meeting all requirements for the relevant Directives. Instrumentation of such equipment shall be the responsibility of the equipment manufacturer.

Generally, machinery or equipment includes not only our products but other devices as well. Manufacturers, therefore, shall design the whole system to be compliant with the relevant Directives.

 EMC certification testing is performed using the following wiring distances between the inverter and motor (shielded wire):

- FRN0.75AQ1■-2□ to FRN45AQ1■-2□ : 75 m
- FRN55AQ1S-2□ to FRN90AQ1S-2□ (inverter alone) : 10 m
- FRN55AQ1S-2□ to FRN90AQ1S-2□ (with filter) : 20 m
- FRN0.75AQ1■-4□ to FRN90AQ1■-4□ : 75 m
- FRN110AQ1S-4□ to FRN710AQ1S-4□ (inverter alone) : 10 m
- FRN110AQ1S-4□ to FRN710AQ1S-4□ (with filter) : 20 m

8.3.2 Recommended installation procedure

To make the machinery or equipment fully compliant with the EMC Directive, have certified technicians wire the motor and inverter in strict accordance with the procedure given below.

- 1) Use shielded wires for the motor cable and route the cable as short as possible. Firmly clamp the shield to the specified point or the grounded metal plate inside the inverter. Further, connect the shielding layer electrically to the grounding terminal of the motor.
- 2) For the inverters of 200V class series 5.5 to 45 kW and 400V ones of 11 to 90 kW, be sure to pass the main circuit power input lines of the inverter through a ferrite core in wiring.
 -  For wiring of the main circuit power input lines, refer to Chapter 2, Section 2.2.1 "(4) Wiring the main circuit power input wires."
- 3) Connect the grounding wires to the grounding terminals without passing them through the ferrite core.

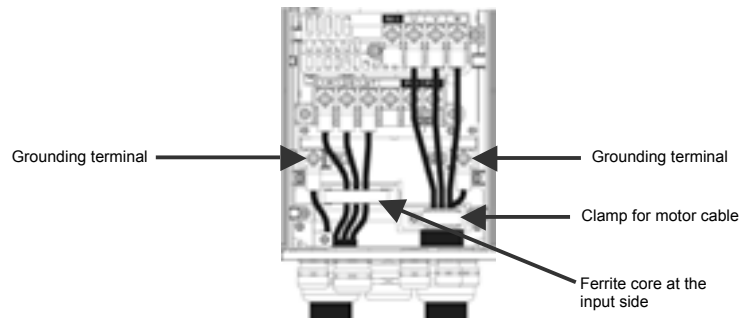
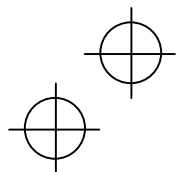
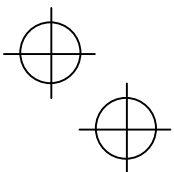
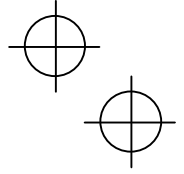
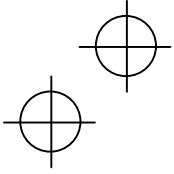

Figure 8.1 Wiring to Main Circuit Terminals





- 4) For connection to inverter's control terminals and for connection of the RS-485 communication signal cable, use shielded wires. As with the motor, clamp the shields firmly to the specified point or the grounded metal plate inside the inverter.

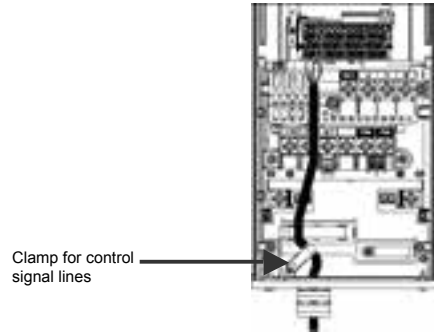

Figure 8.2 Wiring to Control Circuit Terminals

- 5) When using an externally connected EMC filter (optional), place the inverter and filter on a grounded metal plate such as the surface of a panel, as shown in Figure 8.3. If noise emissions exceed the standard, place the inverter and any peripheral equipment inside a metal panel. For more information about how to use the inverter in combination with a filter, see Table 8.4.

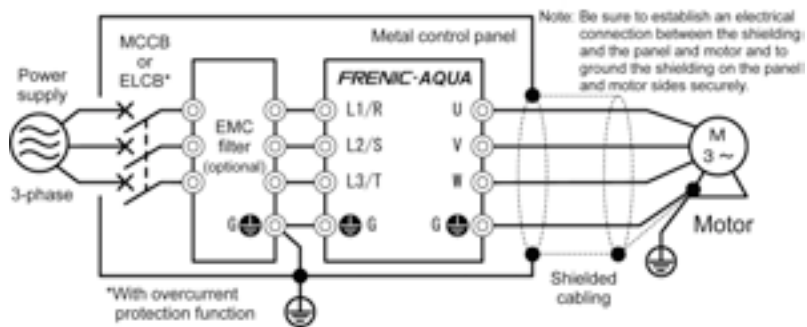

Figure 8.3 Installation inside a Panel

8.3.3 Leakage current of the EMC filter

This product uses grounding capacitors for noise suppression which increase the leakage current. Check whether there is no problem with electrical systems. When using an EMC filter, the leakage current listed in Table 8.4 is added. Before adding the filter, consider whether the additional leakage current is allowable in the context of the overall system design.

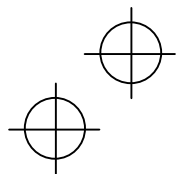
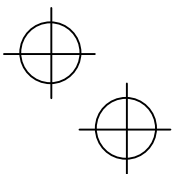

Table 8.3 Leakage current from built-in EMC filter

Input power	Inverter type	Leakage current (mA)		Input power	Inverter type	Leakage current (mA)	
		Normal Conditions	Worst-case Conditions			Normal Conditions	Worst-case Conditions
Three-phase 200 V	FRN0.75AQ1■-2□	86	140	Three-phase 400 V	FRN0.75AQ1■-4□	55	164
	FRN1.5AQ1■-2□						
	FRN2.2AQ1■-2□						
	FRN3.7AQ1■-2□ FRN4.0AQ1■-2E						
	FRN5.5AQ1■-2□	224	357		FRN5.5AQ1■-4□	135	417
	FRN7.5AQ1■-2□						
	FRN11AQ1■-2□						
	FRN15AQ1■-2□	180	291		FRN15AQ1■-4□	111	381
	FRN18.5AQ1■-2□						
	FRN22AQ1■-2□	198	314		FRN22AQ1■-4□	119	367
	FRN30AQ1■-2□						
	FRN37AQ1■-2□	204	322		FRN30AQ1■-4□	148	440
	FRN45AQ1■-2□						
	FRN55AQ1S-2□	18	23		FRN37AQ1■-4□	3	34
FRN75AQ1S-2□							
FRN90AQ1S-2□							
			FRN45AQ1■-4□				
			FRN55AQ1■-4□				
			FRN75AQ1■-4□				
			FRN90AQ1■-4□				
			FRN110AQ1S-4□				
			FRN132AQ1S-4□				
			FRN160AQ1S-4□				
			FRN200AQ1S-4□				
			FRN220AQ1S-4□				
			FRN280AQ1S-4□				
			FRN315AQ1S-4□				
			-				
			FRN355AQ1S-4□				
			FRN400AQ1S-4□				
			FRN500AQ1S-4□				
			FRN630AQ1S-4□				
			FRN710AQ1S-4□				

* Calculated based on these measuring conditions: 200 V, 50 Hz with single-phase grounding, 400 V, 50Hz with neutral grounding, and an interphase voltage unbalance ratio of 2%.

* The worst-case conditions include input phase loss

Note: A box (■) replaces an alphabetic letter depending on the enclosure.
A box (□) replaces an alphabetic letter depending on the shipping destination.

■Enclosure: M (IP21) or L (IP55) □Shipping destination: E (Europe) or A (Asia)

Table 8.4 EMC Filter (Optional) Use and Leakage Currents

Input power	Inverter type	Filter model	EMC filter leakage current (mA)	
			Normal Conditions	Worst-case Conditions
Three-phase 200 V	FRN55AQ1S-2□	FS5536-400-99-1	265	381
	FRN75AQ1S-2□			
	FRN90AQ1S-2□			
Three-phase 400 V	FRN110AQ1S-4□	FS5536-250-99-1	59	364
	FRN132AQ1S-4□			
	FRN160AQ1S-4□	FS5536-400-99-1	78	439
	FRN200AQ1S-4□			
	FRN220AQ1S-4□			
	FRN280AQ1S-4□	FN3359-600-99	38	227
	FRN315AQ1S-4□			
	-	FN3359-800-99	38	227
	FRN355AQ1S-4□			
	FRN400AQ1S-4□	FN3359-1000-99	39	233
	FRN500AQ1S-4□			
FRN630AQ1S-4□	FN3359-1600-99	38	227	
FRN710AQ1S-4□				

* Calculated based on these measuring conditions: 200 V, 50 Hz with single-phase grounding, 400 V, 50Hz with neutral grounding, and an interphase voltage unbalance ratio of 2%.

* The worst-case conditions include input phase loss

Note: A box (□) replaces an alphabetic letter depending on the shipping destination.
 □Shipping destination: E (Europe) or A (Asia)

8.4 Harmonic Component Regulation in the EU

8.4.1 General comments

When general-purpose industrial inverters are used in the EU, the harmonics emitted from inverters to the power lines are strictly regulated as stated below.

If an inverter whose rated input is 1 kW or less is connected to the public low-voltage power supply, it is regulated by the harmonics emission regulation IEC/EN 61000-3-2. If an inverter whose input current is 16 A or above and 75 A or below is connected to the public low-voltage power supply, it is regulated by the harmonics emission regulation IEC/EN 61000-3-12.

Note that connection to the industrial low-voltage power lines is an exception. (See Figure 8.3.)

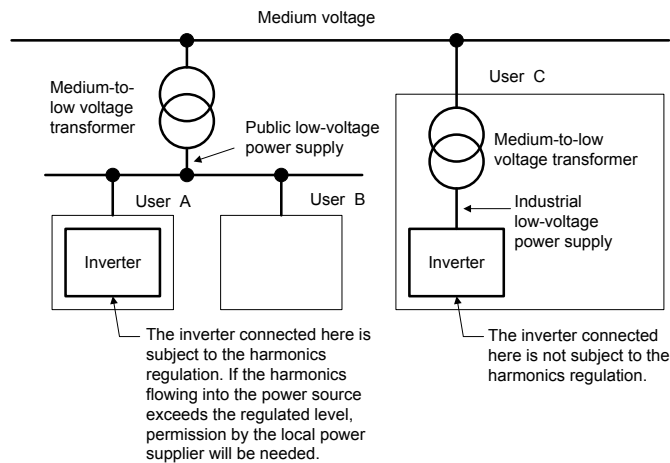
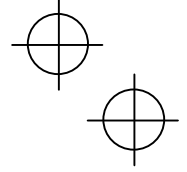
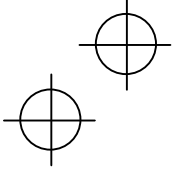

Figure 8.4 Power Source and Regulation



8.4.2 Compliance with IEC/EN 61000-3-2

The FRN0.75AQ1■-4□ satisfies the IEC/EN 61000-3-2, so it can be connected to the public low-voltage power supply.

8.4.3 Compliance with IEC/EN 61000-3-12

To bring the FRN0.75AQ1■-2□ to FRN18.5AQ1■-2□ and FRN0.75AQ1■-4□ to FRN37AQ1■-4□ into compliance with the IEC/EN 61000-3-12, connect them to the power supply whose short-circuit ratio R_{scc} is 120 or above.

8.5 Compliance with UL Standards and cUL-listed for Canada

8.5.1 General

Originally, the UL standards were established by Underwriters Laboratories, Inc. as private criteria for inspections/investigations pertaining to fire/accident insurance in the USA. The UL marking on Fuji products is related to the UL Standard UL508C.

cUL certification means that UL has given certification for products to clear CSA Standards. cUL certified products are equivalent to those compliant with CSA Standards. The cUL marking on Fuji products is related to the CSA Standard C22.2 No. 14.

8.5.2 Considerations when using FRENIC-AQUA in systems to be certified by UL and cUL-listed for Canada

If you want to use the FRENIC-AQUA series of inverters as a part of UL Standards or CSA Standards (cUL certified) certified product, refer to the related guidelines described on pages x to xv.

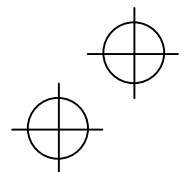
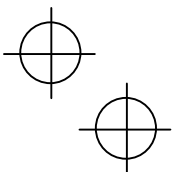

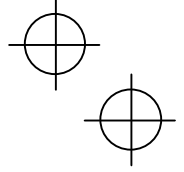
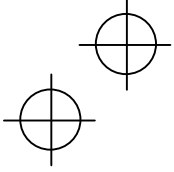

Preface

Thank you for purchasing our FRENIC-AQUA series of inverters. This product is designed to drive a three-phase induction motor.

This instruction manual is translation of the original instructions and provides only minimum requisite information for wiring and operation of the product.

Read through this manual before use.

For details about this product, refer to the FRENIC-AQUA User's Manual that contains the precautions, detailed functions and specifications, wiring, configuration and maintenance.

Related documentation

- FRENIC-AQUA User's Manual

These materials are subject to change without notice. Be sure to obtain the latest editions for use.



We plan to make the latest edition of the User's Manual available for download from the following URL:

(URL) <http://www.fe-frontrunners.eu/drives-inverters/frenic-aqua-frn-aq1>

■ Safety precautions

Read this manual thoroughly before proceeding with installation, connections (wiring), operation, or maintenance and inspection. Ensure you have sound knowledge of the device and familiarize yourself with all safety information and precautions before proceeding to operate the inverter.

Safety precautions are classified into the following two categories in this manual.

 WARNING	Failure to heed the information indicated by this symbol may lead to dangerous conditions, possibly resulting in death or serious bodily injuries.
 CAUTION	Failure to heed the information indicated by this symbol may lead to dangerous conditions, possibly resulting in minor or light bodily injuries and/or substantial property damage.

Failure to heed the information contained under the CAUTION title can also result in serious consequences. These safety precautions are of utmost importance and must be observed at all times.

Application

 WARNING
<ul style="list-style-type: none">• This product is designed to drive a three-phase induction motor. Do not use it for single-phase motors or for other purposes. Fire or an accident could occur.• This product may not be used for a life-support system or other purposes directly related to the human safety.• Although product is manufactured under strict quality control, install safety devices for applications where serious accidents or property damages are foreseen in relation to the failure of it. An accident could occur.

Installation

 WARNING
<ul style="list-style-type: none">• Install the inverter on a base made of metal or other non-flammable material. Otherwise, a fire could occur.• Do not place flammable object nearby.

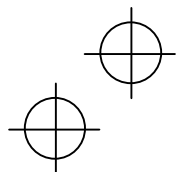
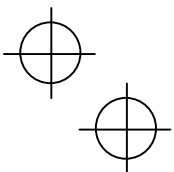

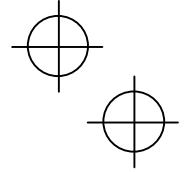
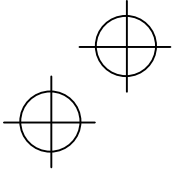

Doing so could cause fire.

⚠ CAUTION

- Do not support the inverter by its front cover during transportation.
Doing so could cause a drop of the inverter and injuries.
- Prevent lint, paper fibers, sawdust, dust, metallic chips, or other foreign materials from getting into the inverter or from accumulating on the heat sink.
- When changing the positions of the top and bottom mounting bases, use only the specified screws.
Otherwise, a fire or an accident might result.
- Do not install or operate an inverter that is damaged or lacking parts.
Doing so could cause fire, an accident or injuries.

Wiring

⚠ WARNING ⚠

- If there isn't zero-phase current (Earth leakage current) detective device, such as a ground-fault relay in the upstream power supply line, which is to avoid undesirable system shutdown, install a residual-current-operated protective device (RCD)/earth leakage circuit breaker (ELCB) individually to break the individual inverter's power supply line.
Otherwise, a fire could occur.
- When wiring the inverter to the power source, insert a recommended molded case circuit breaker (MCCB) or residual-current-operated protective device (RCD)/earth leakage circuit breaker (ELCB) (with overcurrent protection) in the path of each pair of power lines to inverters. Use the recommended devices within the recommended current capacity.
- Use wires in the specified size.
- Tighten terminals with specified torque.
Otherwise, a fire could occur.
- When there is more than one combination of an inverter and motor, do not use a multicore cable for the purpose of running their wirings together.
- Do not connect a surge killer to the inverter's output (secondary) circuit.
Doing so could cause a fire.
- Be sure to ground the inverter's grounding terminals G.
Otherwise, an electric shock or a fire could occur.
- Qualified electricians should carry out wiring.
- Be sure to perform wiring after turning the power OFF.
Otherwise, an electric shock could occur.
- Be sure to perform wiring after installing the inverter unit.
Otherwise, an electric shock or injuries could occur.
- Ensure that the number of input phases and the rated voltage of the product match the number of phases and the voltage of the AC power supply to which the product is to be connected.
- When using this product in combination with a PWM converter, refer to the instructions given in the FRENIC-AQUA User's Manual.
Otherwise, a fire or an accident could occur.
- Do not connect the power supply wires to the inverter output terminals (U, V, and W).
Doing so could cause fire or an accident.

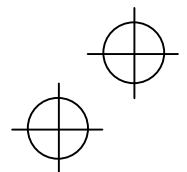
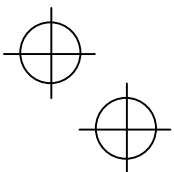

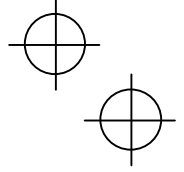
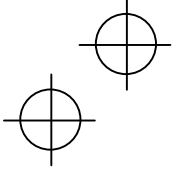

⚠ WARNING ⚠

- In general, sheaths of the control signal wires are not specifically designed to withstand a high voltage (i.e., reinforced insulation is not applied). Therefore, if a control signal wire comes into direct contact with a live conductor of the main circuit, the insulation of the sheath might break down, which would expose the signal wire to a high voltage of the main circuit. Make sure that the control signal wires will not come into contact with live conductors of the main circuit.

Doing so could cause an accident or an electric shock.

⚠ WARNING ⚠

- Before changing the switches, **turn OFF the power and wait at least 10 minutes**. Make sure that the charging lamp is turned OFF. Further, make sure, using a multimeter or a similar instrument, that the DC link bus voltage between the terminals P(+) and N(-) has dropped to the safe level (+25 VDC or below).

Otherwise, an electric shock could occur.

⚠ CAUTION ⚠

- The inverter, motor and wiring generate electric noise. Be careful about malfunction of the nearby sensors and devices. To prevent them from malfunctioning, implement noise control measures.

Otherwise an accident could occur.

- The leakage current of the EMC filter built-in type of inverters is comparatively large. Be sure to perform protective grounding.

Otherwise, an accident or an electric shock could occur.

Operation

⚠ WARNING ⚠

- Be sure to mount the front cover before turning the power ON. Do not remove the cover when the inverter power is ON.

Otherwise, an electric shock could occur.

- Do not operate switches with wet hands.



Doing so could cause electric shock.

- If the auto-reset function has been selected, the inverter may automatically restart and drive the motor depending on the cause of tripping. Design the machinery or equipment so that human safety is ensured at the time of restarting.

Otherwise, an accident could occur.

- If the stall prevention function (current limiter), automatic deceleration (anti-regenerative control), or overload prevention control has been selected, the inverter may operate with acceleration/deceleration or frequency different from the commanded ones. Design the machine so that safety is ensured even in such cases.

- The  key on the keypad is effective only when the keypad operation is enabled with function code F02 (= 0, 2 or 3). When the keypad operation is disabled, prepare an emergency stop switch separately for safe operations.

Switching the run command source from keypad (local) to external equipment (remote) by turning ON the "Enable communications link" command **LE** disables the  key. To enable the  key for an emergency stop, select the STOP key priority with function code H96 (= 1 or 3).

- If any of the protective functions have been activated, first remove the cause. Then, after checking that all the run commands are set to OFF, release the alarm. If the alarm is released while any run commands are set to ON, the inverter may supply the power to the motor, running the motor.

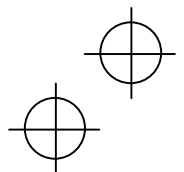
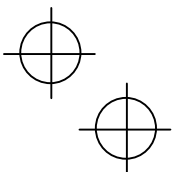

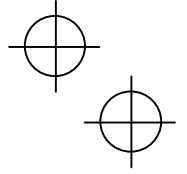
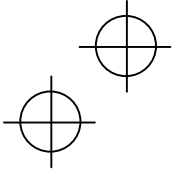

Otherwise, an accident could occur.

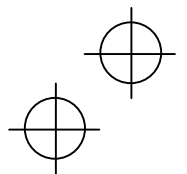
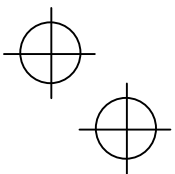

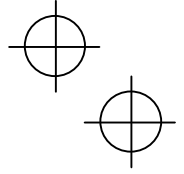
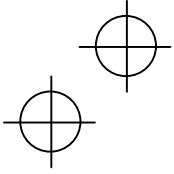

⚠ WARNING ⚠

- If you enable the "Restart mode after momentary power failure" (Function code F14 = 3 to 5), then the inverter automatically restarts running the motor when the power is recovered.
Design the machinery or equipment so that human safety is ensured after restarting.
- If the user configures the function codes wrong without completely understanding this Instruction Manual and the FRENIC-AQUA User's Manual, the motor may rotate with a torque or at a speed not permitted for the machine.
An accident or injuries could occur.
- Even if the inverter has interrupted power to the motor, if the voltage is applied to the main circuit input terminals L1/R, L2/S and L3/T, voltage may be output to inverter output terminals U, V, and W.
- Even if the motor is stopped due to DC braking, voltage is output to inverter output terminals U, V, and W.
An electric shock may occur.
- The inverter can easily accept high-speed operation. When changing the speed setting, carefully check the specifications of motors or equipment beforehand.
Otherwise, injuries could occur.

⚠ CAUTION ⚠

- Do not touch the heat sink because it becomes very hot.
Doing so could cause burns.
- The DC brake function of the inverter does not provide any holding mechanism.
Injuries could occur.
- Ensure safety before modifying the function code settings.
Run commands (e.g., "Run forward" **FWD**, "FMS is switch to fire mode" **FMS**), stop commands (e.g., "Coast to a stop" **BX**), and frequency change commands can be assigned to digital input terminals. Depending upon the assignment states of those terminals, modifying the function code setting may cause a sudden motor start or an abrupt change in speed.
- When the inverter is controlled with the digital input signals, switching run or frequency command sources with the related terminal commands (e.g., **SS1**, **SS2**, **SS4**, **SS8**, **Hz2/Hz1**, **Hz/PID**, **IVS**, **LE** and **FMS**) may cause a sudden motor start or an abrupt change in speed.
- Ensure safety before modifying customizable logic related function code settings (U codes and related function codes) or turning ON the "Cancel customizable logic" terminal command **CLC**. Depending upon the settings, such modification or cancellation of the customizable logic may change the operation sequence to cause a sudden motor start or an unexpected motor operation.
- If any abnormality is found in the inverter or motor, immediately stop it and perform troubleshooting, referring to the FRENIC-AQUA User's Manual.
An accident or injuries could occur.

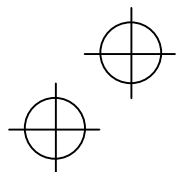
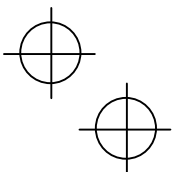

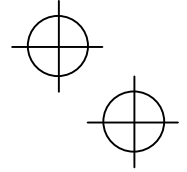
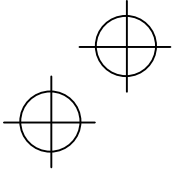

Maintenance and inspection, and parts replacement

WARNING

- Before proceeding to maintenance or inspection, **turn OFF the power and wait at least 10 minutes.** Make sure that the charging lamp is turned OFF. Further, make sure, using a multimeter or a similar instrument, that the DC link bus voltage between the terminals P(+) and N(-) has dropped to the safe level (+25 VDC or below).
Otherwise, an electric shock could occur.
- Always carry out the daily and periodic inspections described in the user's manual. Use of the inverter for long periods of time without carrying out regular inspections could result in malfunction or damage, and an accident or fire could occur.
- It is recommended that periodic inspections be carryout every one to two years, however, they should be carried out more frequently depending on the usage conditions.
- It is recommended that parts for periodic replacement be replaced in accordance with the standard replacement frequency indicated in the user's manual. Use of the product for long periods of time without replacement could result in malfunction or damage, and an accident or fire could occur.
- Contact outputs [30A/B/C] [Y5A/C] use relays, and may remain ON, OFF, or undetermined when their lifetime is reached. In the interests of safety, equip the inverter with an external protective function.
- Continued use of a depleted backup battery may result in loss of data.
Otherwise, an accident or fire could occur.
- Maintenance, inspection, and parts replacement should be made only by qualified persons.
- Take off the watches, rings and other metallic objects before starting work.
- Use insulated tools.
Otherwise, an electric shock or injuries could occur.
- Never modify the inverter.
Doing so could cause an electric shock or injuries.

Disposal

CAUTION

- Treat the inverter as an industrial waste when disposing of it.
Otherwise injuries could occur.

GENERAL PRECAUTIONS

Drawings in this manual may be illustrated without covers or safety shields for explanation of detail parts. Restore the covers and shields in the original state and observe the description in the manual before starting operation.

Icons

The following icons are used throughout this manual.



This icon indicates information which, if not heeded, can result in the inverter not operating to full efficiency, as well as information concerning incorrect operations and settings which can result in accidents.



This icon indicates information that can prove handy when performing certain settings or operations.



This icon indicates a reference to more detailed information.

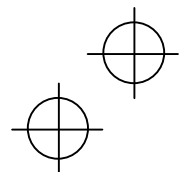
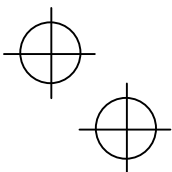

Conformity to the Low Voltage Directive in the EU

If installed according to the guidelines given below, inverters marked with CE are considered as compliant with the Low Voltage Directive 2006/95/EC.

Compliance with European Standards

Adjustable speed electrical power drive systems (PDS).

Part 5-1: Safety requirements. Electrical, thermal and energy. IEC/EN 61800-5-1: 2007

⚠ WARNING ⚠

- The ground terminal **G** should always be connected to the ground. Do not use only a residual-current-operated protective device (RCD)/earth leakage circuit breaker (ELCB)* as the sole method of electric shock protection. Be sure to use ground wires of recommended size listed on page vii.
*With overcurrent protection.
- To prevent the risk of hazardous accidents that could be caused by damage of the inverter, install the specified fuses in the supply side (primary side) according to the following tables.
 - Breaking capacity: Min. 10 kA
 - Rated voltage: Min. 500 V

Power supply voltage	Nominal applied motor (kW)	Inverter type	Fuse rating (A)	Power supply voltage	Nominal applied motor (kW)	Inverter type	Fuse rating (A)
Three-phase 200 V	0.75	FRN0.75AQ1■-2□	6(IEC/EN 60269-2)	Three-phase 400 V	0.75	FRN0.75AQ1■-4□	4(IEC/EN 60269-2)
	1.5	FRN1.5AQ1■-2□	10(IEC/EN 60269-2)		1.5	FRN1.5AQ1■-4□	6(IEC/EN 60269-2)
	2.2	FRN2.2AQ1■-2□	16(IEC/EN 60269-2)		2.2	FRN2.2AQ1■-4□	10(IEC/EN 60269-2)
	3.7 (4.0)*	FRN3.7AQ1■-2□ FRN4.0AQ1■-2E	25(IEC/EN 60269-2)		3.7 (4.0)*	FRN3.7AQ1■-4□ FRN4.0AQ1■-4E	16(IEC/EN 60269-2)
	5.5	FRN5.5AQ1■-2□	35(IEC/EN 60269-2)		5.5	FRN5.5AQ1■-4□	20(IEC/EN 60269-2)
	7.5	FRN7.5AQ1■-2□	50(IEC/EN 60269-2)		7.5	FRN7.5AQ1■-4□	25(IEC/EN 60269-2)
	11	FRN11AQ1■-2□	80(IEC/EN 60269-2)		11	FRN11AQ1■-4□	35(IEC/EN 60269-2)
	15	FRN15AQ1■-2□	100(IEC/EN 60269-2)		15	FRN15AQ1■-4□	50(IEC/EN 60269-2)
	18.5	FRN18.5AQ1■-2□	125(IEC/EN 60269-2)		18.5	FRN18.5AQ1■-4□	63(IEC/EN 60269-2)
	22	FRN22AQ1■-2□	250(IEC 60269-4)		22	FRN22AQ1■-4□	80(IEC/EN 60269-2)
	30	FRN30AQ1■-2□			30	FRN30AQ1■-4□	100(IEC/EN 60269-2)
	37	FRN37AQ1■-2□	350(IEC 60269-4)		37	FRN37AQ1■-4□	125(IEC/EN 60269-2)
	45	FRN45AQ1■-2□			45	FRN45AQ1■-4□	250(IEC 60269-4)
55	FRN55AQ1S-2□	500(IEC 60269-4)	55	FRN55AQ1■-4□	75	FRN75AQ1■-4□	
75	FRN75AQ1S-2□		75	FRN75AQ1■-4□	350(IEC 60269-4)		
90	FRN90AQ1S-2□		90	FRN90AQ1■-4□		110	FRN110AQ1S-4□
				132	FRN132AQ1S-4□	400 (IEC 60269-4)	
				160	FRN160AQ1S-4□	450 (IEC 60269-4)	
				200	FRN200AQ1S-4□	500 (IEC 60269-4)	
				220	FRN220AQ1S-4□	550 (IEC 60269-4)	
				280	FRN280AQ1S-4□	630 (IEC 60269-4)	
				315	FRN315AQ1S-4□	900 (IEC 60269-4)	
				355	FRN355AQ1S-4□		
				400	FRN400AQ1S-4□	1250 (IEC 60269-4)	
				500	FRN500AQ1S-4□		
				630	FRN630AQ1S-4□	2000 (IEC 60269-4)	
				710	FRN710AQ1S-4□		

* 4.0 kW for the EU. The inverter type is FRN4.0AQ1■-2E or FRN4.0AQ1■-4E.

Note: A box (■) replaces an alphabetic letter depending on the enclosure.

A box (□) replaces an alphabetic letter depending on the shipping destination.

■Enclosure: M (IP21) or L (IP55) □Shipping destination: E (Europe) or A (Asia)

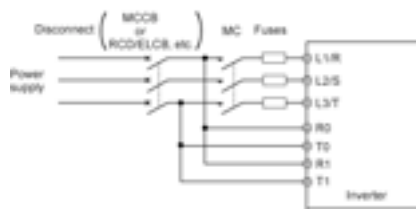

Conformity to the Low Voltage Directive in the EU (Continued)

⚠ WARNING ⚠

3. When used with the inverter, a molded case circuit breaker (MCCB), residual-current-operated protective device (RCD)/earth leakage circuit breaker (ELCB) or magnetic contactor (MC) should conform to the EN or IEC standards.
4. When you use a residual-current-operated protective device (RCD)/earth leakage circuit breaker (ELCB) for protection from electric shock in direct or indirect contact power lines or nodes, be sure to install **type B of RCD/ELCB** on the input (primary) of the inverter.
5. The inverter should be used in an environment that does not exceed Pollution Degree 2 requirements.
6. Install the inverter, AC reactor (ACR), input or output filter in an enclosure with minimum degree of protection of IP2X (Top surface of enclosure shall be minimum IP4X when it can be easily accessed), to prevent human body from touching directly to live parts of these equipment.
Note: Does not apply to IP55 model.
7. Do not connect any copper wire directly to grounding terminals. Use crimp terminals with tin or equivalent plating to connect them.
8. When you use an inverter at an altitude of more than 2000 m, you should apply basic insulation for the control circuits of the inverter. The inverter cannot be used at altitudes of more than 3000 m.

Conformity to the Low Voltage Directive in the EU (Continued)



9. Use wires listed in IEC 60364-5-52.

Power supply voltage	Nominal applied motor (kW)	Inverter type	Recommended wire size (mm ²)						
			Main terminal		DC reactor connection [P1, P(+)] *1	Control circuit	Aux. control power supply [R0, T0]	Aux main power supply [R1, T1]	
			Main power input [L1/R, L2/S, L3/T] *1	Inverter's grounding [G] *1					Inverter outputs [U, V, W] *1
Three-phase 200 V	0.75	FRN0.75AQ1-2□	2.5	10	2.5	Built-in DC reactor	0.75	2.5	-
	1.5	FRN1.5AQ1-2□							
	2.2	FRN2.2AQ1-2□							
	3.7	FRN3.7AQ1-2□							
	(4.0)*	FRN4.0AQ1-2E							
	5.5	FRN5.5AQ1-2□	4	10	6				
	7.5	FRN7.5AQ1-2□							
	11	FRN11AQ1-2□	10	10	16				
	15	FRN15AQ1-2□	25	16					
	18.5	FRN18.5AQ1-2□		25					
	22	FRN22AQ1-2□		35					
	30	FRN30AQ1-2□	50	50					
	37	FRN37AQ1-2□	70	70					
	45	FRN45AQ1-2□		95					
	55	FRN55AQ1S-2□	50×2	70×2	70×2				
75	FRN75AQ1S-2□	95×2	95×2	95×2					
90	FRN90AQ1S-2□	120×2	120×2	120×2					
Three-phase 400 V	0.75	FRN0.75AQ1-4□	2.5	10	2.5	Built-in DC reactor	0.75	2.5	-
	1.5	FRN1.5AQ1-4□							
	2.2	FRN2.2AQ1-4□							
	3.7	FRN3.7AQ1-4□							
	(4.0)*	FRN4.0AQ1-4E							
	5.5	FRN5.5AQ1-4□	4	10	4				
	7.5	FRN7.5AQ1-4□							
	11	FRN11AQ1-4□	4	6	10				
	15	FRN15AQ1-4□	4	6					
	18.5	FRN18.5AQ1-4□	6	10					
	22	FRN22AQ1-4□	10	16					
	30	FRN30AQ1-4□	25	16					
	37	FRN37AQ1-4□	25	25					
	45	FRN45AQ1-4□		35					
	55	FRN55AQ1-4□	35	50	70				
	75	FRN75AQ1-4□	70	70					
	90	FRN90AQ1-4□	95	95					
	110	FRN110AQ1S-4□	50×2	70×2	150				
	132	FRN132AQ1S-4□	70×2	70×2	70×2				
	160	FRN160AQ1S-4□	185	240	300				
	200	FRN200AQ1S-4□	300	300	120×2				
220	FRN220AQ1S-4□	300	150×2	150×2					
280	FRN280AQ1S-4□	240×2	240×2	240×2					
315	FRN315AQ1S-4□	240×2	300×2	300×2					
355	FRN355AQ1S-4□	300×2	300×2	300×2					
400	FRN400AQ1S-4□	240×3	240×3	300×3					
500	FRN500AQ1S-4□	300×3	240×4	300×4					
630	FRN630AQ1S-4□	340×4	300×4	300×4					
710	FRN710AQ1S-4□	340×4	300×4	300×4					

* 4.0 kW for the EU. The inverter type is FRN4.0AQ1-2E or FRN4.0AQ1-4E.

Note: A box (■) replaces an alphabetic letter depending on the enclosure.

A box (□) replaces an alphabetic letter depending on the shipping destination.

■ Enclosure: M (IP21) or L (IP55) □ Shipping destination: E (Europe) or A (Asia)

*1 The recommended wire size for main circuits is for the 70°C 600 V PVC wires used at an ambient temperature of 40°C.

Conformity to the Low Voltage Directive in the EU (Continued)



10. The inverter has been tested with IEC/EN 61800-5-1 2007 Short-circuit Test under the following conditions.

- Short-circuit current in the supply: 10,000 A
- 240V or below (200V class series inverters of 18.5 kW or below.)
- 230V or below (230V class series inverters of 22 kW or above.)
- 480V or below (480V class series inverters)

11. Use this inverter at the following power supply system.

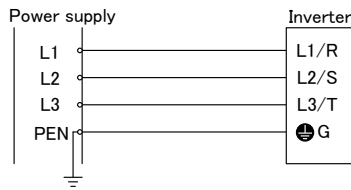

TN-C system

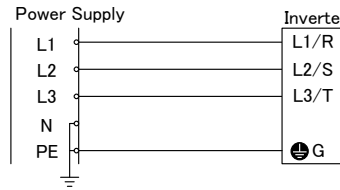

TN-S system

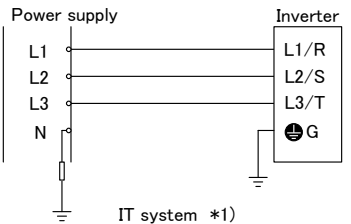

IT system *1)

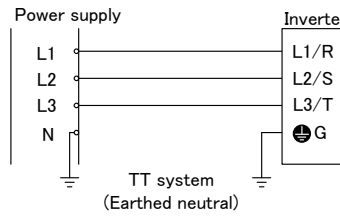

TT system
(Earthed neutral)

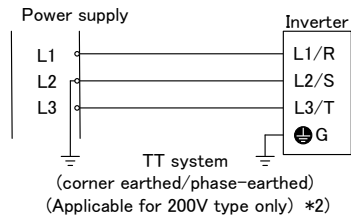

TT system
(corner earthed/phase-earthed)
(Applicable for 200V type only) *2)

*1 Use this inverter at the following IT system.

Non-earthed (isolated from earth) IT system	Can be used. In this case the insulation between the control interface and the main circuit of the inverter is basic insulation.
IT system which earthed neutral by an impedance	Thus do not connect SELV circuit from external controller directly (make connection using a supplementary insulation.). Use an earth fault detector able to disconnect the power within 5s after the earth fault occurs.
Corner earthed / Phase-earthed IT system by an impedance	Can not be used

*2 Cannot apply to Corner earthed / Phase-earthed TT system except 200V type.

Conformity with UL standards and cUL-listed for Canada

UL/cUL-listed inverters are subject to the regulations set forth by the UL standards and CSA standards (cUL-listed for Canada) by installation within precautions listed below.

⚠ CAUTION

1. Solid state motor overload protection (motor protection by electronic thermal overload relay) is provided in each model.
Use function codes F10 to F12 to set the protection level.
2. Use 75°C Cu wire only.
3. Use Class 1 wire only for control circuits.
4. Short circuit rating

"Suitable For Use On A Circuit Of Delivering Not More Than 100,000 rms Symmetrical Amperes, 240 Volts Maximum for 200V class input 18.5 kW or less, 230 Volts Maximum for 200V class input 22 kW or above when protected by Class J Fuses or a Circuit Breaker having an interrupting rating not less than 100,000 rms Symmetrical Amperes, 240 Volts Maximum. Models FRN; rated for 200V class input.

"Suitable For Use On A Circuit Of Delivering Not More Than 100,000 rms Symmetrical Amperes, 480 Volts Maximum when protected by Class J Fuses or a Circuit Breaker having an interrupting rating not less than 100,000 rms Symmetrical Amperes, 480 Volts Maximum. Models FRN; rated for 400V class input.

"Integral solid state short circuit protection does not provide branch circuit protection. Branch circuit protection must be provided in accordance with the National Electrical Code and any additional local codes."

5. Field wiring connections must be made by a UL Listed and CSA Certified closed-loop terminal connector sized for the wire gauge involved. Connector must be fixed using the crimp tool specified by the connector manufacturer.
6. All circuits with terminals L1/R, L2/S, L3/T, R0, T0, R1, T1 must have a common disconnect and be connected to the same pole of the disconnect if the terminals are connected to the power supply.

Terminals R0, T0 must be protected by Class J Fuses or a Circuit Breakers for all capacity in the figure below.
Terminals R1, T1 must be protected by Class J Fuses or a Circuit Breakers in the figure below. (200V class series 55kW only)

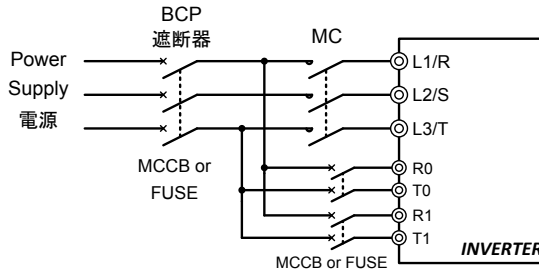

7. Environmental rating

- Maximum Surrounding Air Temperature / Maximum ambient temperature.

The surrounding temperature and ambient temperature shall be lower than the values in the table below.

Type	Temperature
FRN__AQ1S-□□ / FRN__AQ1M-□□	50 deg C
FRN__AQ1U-□□ / FRN__AQ1L-□□	40 deg C

- Atmosphere

For use in pollution degree 2 environments.

Conformity with UL standards and cUL-listed for Canada (continued)

CAUTION

8. UL enclosure type

UL enclosed type formats are shown in the table below.

Enclosure Type	Type
Open Type	FRN_ _ _AQ1S-□□
Type 1	FRN_ _ _AQ1M-□□
Type 12	FRN_ _ _AQ1L-□□

9. Plenum rated drives

UL Enclosed Type is suitable for installation in a compartment handling conditioned air.

10. Mounting the wiring plate

To use inverters with cable ground plate as standard intended for Europe and so on as UL compliant products, attach a separate conduit plate.

11. Functional description of control circuit terminals

A power source for connection to the Integrated alarm output (30A, 30B, 30C) should be limited to overvoltage category II such as control circuit or secondary winding of power transformer.

Classification	Terminal Symbol	Terminal Name	Functional description
Contact output	[30A/B/C]	Alarm relay output	When the inverter stops with an alarm, output is generated on the relay contact (1C). Contact capacitance: 250 VAC 0.3A cosφ=1.0, 48 VDC 0.5 A

Conformity with UL standards and cUL-listed for Canada (continued)

CAUTION

12. Install UL certified fuses or circuit breaker between the power supply and the inverter, referring to the table below. The tightening torque is as follows.

Power supply voltage	Nominal applied motor (kW)	Inverter type	Class J fuse size (A) *1	Circuit breaker trip size (A) *1	Required torque lb-in (N · m)				
					Main terminal	Control circuit	Aux. control power supply	Aux. main power supply	
Three-phase 200V	0.75	FRN0.75AQ1■-2□	10	5	15.9 (1.8)	6.1 (0.7)	10.6 (1.2)	-	
	1.5	FRN1.5AQ1■-2□		10					
	2.2	FRN2.2AQ1■-2□	15						
	3.7 (4.0) [†]	FRN3.7AQ1■-2□ FRN4.0AQ1■-2E	25	20					
	5.5	FRN5.5AQ1■-2□	35	30	51.3 (5.8)				
	7.5	FRN7.5AQ1■-2□	50	40					
	11	FRN11AQ1■-2□	70	50	119 (13.5)				
	15	FRN15AQ1■-2□	100	75					
	18.5	FRN18.5AQ1■-2□	125	100					
	22	FRN22AQ1■-2□	-	100 (*2)	239 (27)				10.6 (1.2)
	30	FRN30AQ1■-2□		150 (*2)					
	37	FRN37AQ1■-2□		175 (*2)					
	45	FRN45AQ1■-2□		200 (*2)					
	55	FRN55AQ1S-2□	350	250	425(48)				
75	FRN75AQ1S-2□	500	350						
90	FRN90AQ1S-2□	600	400						

* 4.0 kW for the EU. The inverter type is FRN4.0AQ1■-2E.

Note: A box (■) replaces an alphabetic letter depending on the enclosure.

A box (□) replaces an alphabetic letter depending on the shipping destination.

■Enclosure: M (IP21) or L (IP55) □Shipping destination: E (Europe) or A (Asia)

*1 Not more than 6 rms Amperes fuses or not more than 5 rms Amperes breakers for aux. control power supply and aux. main power supply.

*2 Protect the inverter by both a circuit breaker and the fuse tabulated below connected in series.

Inverter type	Fuse type	
	Made by Mersen	Made by Bussmann
FRN22AQ1■-2□	A70QS250-4	FWP-250A
FRN30AQ1■-2□		
FRN37AQ1■-2□	A70QS350-4	FWP-350A
FRN45AQ1■-2□		

Conformity with UL standards and cUL-listed for Canada (continued)

CAUTION

Power supply voltage	Nominal applied motor (kW)	Inverter type	Class J fuse size (A) *1	Circuit breaker trip size (A) *1	Required torque lb-in (N · m)				
					Main terminal	Control circuit	Aux. control power supply	Aux. main power supply	
Three-phase 400V	0.75	FRN0.75AQ1■-4□	3	5	15.9 (1.8)	6.1 (0.7)	10.6 (1.2)		
	1.5	FRN1.5AQ1■-4□	6						
	2.2	FRN2.2AQ1■-4□	10						
	3.7 (4.0)	FRN3.7AQ1■-4□ FRN4.0AQ1■-4E	15	10					
	5.5	FRN5.5AQ1■-4□	20						
	7.5	FRN7.5AQ1■-4□	25	20					
	11	FRN11AQ1■-4□	35	30					
	15	FRN15AQ1■-4□	50	40					
	18.5	FRN18.5AQ1■-4□	60	50					51.3 (5.8)
	22	FRN22AQ1■-4□	70						
	30	FRN30AQ1■-4□	100	75					
	37	FRN37AQ1■-4□	125	100					
	45	FRN45AQ1■-4□	-	100 (*2)	119 (13.5)				
	55	FRN55AQ1■-4□		150 (*2)					
	75	FRN75AQ1■-4□		175 (*2)					
	90	FRN90AQ1■-4□		200 (*2)	239 (27)				
	110	FRN110AQ1S-4□	350	250					
	132	FRN132AQ1S-4□	400	300					
	160	FRN160AQ1S-4□	500	350					
	200	FRN200AQ1S-4□	600	500	425 (48)				
	220	FRN220AQ1S-4□	-						
280	FRN280AQ1S-4□	-	600						
315	FRN315AQ1S-4□	-	800						
355	FRN355AQ1S-4□	-							
400	FRN400AQ1S-4□	-	1200						
500	FRN500AQ1S-4□	-							
630	FRN630AQ1S-4□	-		1400					
710	FRN710AQ1S-4□	-	1600						

* 4.0 kW for the EU. The inverter type is FRN4.0AQ1■-4E.

Note: A box (■) replaces an alphabetic letter depending on the enclosure.

A box (□) replaces an alphabetic letter depending on the shipping destination.

■Enclosure: M (IP21) or L (IP55) □Shipping destination: E (Europe) or A (Asia)

*1 Not more than 6 rms Amperes fuses or not more than 5 rms Amperes breakers for aux. control power supply and aux. main power supply.

*2 Protect the inverter by both circuit breaker and the fuse tabulated below connected in series.

Inverter type	Fuse type	
	Made by Mersen	Made by Bussmann
FRN45AQ1■-4□	A70QS250-4	FWP-250A
FRN55AQ1■-4□		
FRN75AQ1■-4□	A70QS350-4	FWP-350A
FRN90AQ1■-4□		

Conformity with UL standards and cUL-listed for Canada (continued)

CAUTION

Power supply voltage	Nominal applied motor (kW)	Inverter type	Wire size AWG (mm ²)					
			Main terminal		Cu wire	Control circuit	Aux. control power supply	Aux. main power supply
			L1/R, L2/S, L3/T	U, V, W				
			75°C Cu wire	75°C Cu wire				
Three-phase 200V	0.75	FRN0.75AQ1■-2□	14 (2.1) *1	14 (2.1) *1	18 (0.8) *2	14 (2.1) *2		
	1.5	FRN1.5AQ1■-2□						
	2.2	FRN2.2AQ1■-2□						
	3.7 (4.0)	FRN3.7AQ1■-2□ FRN4.0AQ1■-2E	12 (3.3) *1	10 (5.3) *1				
	5.5	FRN5.5AQ1■-2□						
	7.5	FRN7.5AQ1■-2□	8 (8.4)	6 (13.3)				
	11	FRN11AQ1■-2□						
	15	FRN15AQ1■-2□	4 (21.2)	2 (33.6)				
	18.5	FRN18.5AQ1■-2□						
	22	FRN22AQ1■-2□						
	30	FRN30AQ1■-2□	2 (33.6)	1/0 (53.5)				
	37	FRN37AQ1■-2□						
	45	FRN45AQ1■-2□	2/0 (67.4)	3/0 (85)				
	55	FRN55AQ1S-2□	4/0 (107.2)	4/0 (107.2)				
	75	FRN75AQ1S-2□	3/0 × 2 (85 × 2)	3/0 × 2 (85 × 2)				
90	FRN90AQ1S-2□	4/0 × 2 (107.2 × 2)	4/0 × 2 (107.2 × 2)					

* 4.0 kW for the EU. The inverter type is FRN4.0AQ1■-2E.

Note: A box (■) replaces an alphabetic letter depending on the enclosure.

A box (□) replaces an alphabetic letter depending on the shipping destination.

■ Enclosure: M (IP21) or L (IP55) □ Shipping destination: E (Europe) or A (Asia)

Note: The inverter's grounding wire size must be provided in accordance with the National Electrical Code.

*1 No terminal end treatment is required for connection.

*2 Use 75°C Cu wire only.

Conformity with UL standards and cUL-listed for Canada (continued)

CAUTION

Power supply voltage	Nominal applied motor (kW)	Inverter type	Wire size AWG (mm ²)				
			Main terminal		Control circuit	Aux. control power supply	Aux. main power supply
			L1/R, L2/S, L3/T	U, V, W			
		75°C Cu wire	75°C Cu wire				
Three-phase 400V	0.75	FRN0.75AQ1■-4□	14 (2.1) *1	14 (2.1) *1	18 (0.8) *2	14 (2.1) *1 *2	-
	1.5	FRN1.5AQ1■-4□					
	2.2	FRN2.2AQ1■-4□					
	3.7 (4.0) *	FRN3.7AQ1■-4□ FRN4.0AQ1■-4E					
	5.5	FRN5.5AQ1■-4□					
	7.5	FRN7.5AQ1■-4□					
	11	FRN11AQ1■-4□	12 (3.3) *1	10 (5.3) *1			
	15	FRN15AQ1■-4□	10 (5.3) *1	8 (8.4)			
	18.5	FRN18.5AQ1■-4□	8 (8.4)				
	22	FRN22AQ1■-4□		6 (13.3)			
	30	FRN30AQ1■-4□					
	37	FRN37AQ1■-4□	4 (21.2)	2 (33.6)			
	45	FRN45AQ1■-4□					
	55	FRN55AQ1■-4□	2 (33.6)	1/0 (53.5)			
	75	FRN75AQ1■-4□	1/0 (53.5)				
	90	FRN90AQ1■-4□	2/0 (67.4)	3/0 (85)			
	110	FRN110AQ1S-4□	1/0×2 (53.5×2)	1/0×2 (53.5×2)			
	132	FRN132AQ1S-4□		2/0×2 (67.4×2)			
	160	FRN160AQ1S-4□	3/0×2 (85×2)	3/0×2 (85×2)			
	200	FRN200AQ1S-4□	4/0×2 (107.2×2)	250×2 (127×2)			
	220	FRN220AQ1S-4□	250×2 (127×2)	300×2 (152×2)			
	280	FRN280AQ1S-4□	400×2 (203×2)	400×2 (203×2)			
	315	FRN315AQ1S-4□	300×2 (152×2)	350×2 (177×2)			
355	FRN355AQ1S-4□	400×2 (203×2)	400×2 (203×2)				
400	FRN400AQ1S-4□	500×2 (253×2)	500×2 (253×2)				
500	FRN500AQ1S-4□	350×3 (177×3)	400×3 (203×3)				
630	FRN630AQ1S-4□	500×3 (253×3)	600×3 (304×3)				
710	FRN710AQ1S-4□	600×3 (304×3)	500×4 (253×4)				

* 4.0 kW for the EU. The inverter type is FRN4.0AQ1■-4E.

Note: A box (■) replaces an alphabetic letter depending on the enclosure.

A box (□) replaces an alphabetic letter depending on the shipping destination.

■Enclosure: M (IP21) or L (IP55) □Shipping destination: E (Europe) or A (Asia)

Note: The inverter's grounding wire size must be provided in accordance with the National Electrical Code.

*1 No terminal end treatment is required for connection.

*2 Use 75°C Cu wire only.

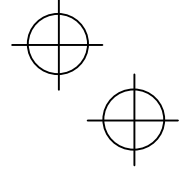
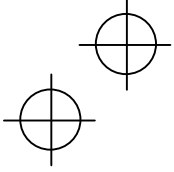
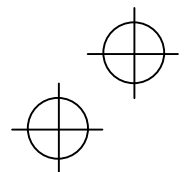
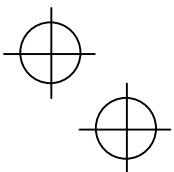
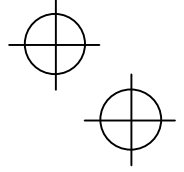
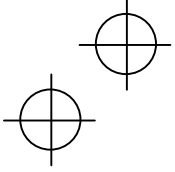

Table of Contents

Preface	i
■ Safety precautions	i
Conformity to the Low Voltage Directive in the EU	vii
Conformity with UL standards and cUL-listed for Canada	xi
Product Warranty	xviii
Chapter 1 BEFORE USE	1
1.1 Acceptance Inspection and Appearance of Product	1
1.2 Precautions for Using Inverters	2
1.3 Usage environment and Strage enviroment	3
1.3.1 Usage environment	3
1.3.2 Strage environment	4
Chapter 2 MOUNTING AND WIRING THE INVERTER ..	2-1
2.1 Installing the Inverter	2-1
2.2 Wiring	2-1
2.2.1 Removing and mounting the front cover and the wiring plate	2-1
2.2.2 Recommended wire sizes	2-5
2.2.3 Terminal arrangement diagrams and screw specifications	2-5
2.2.4 Terminal functions and wiring order	2-10
2.2.5 Connection diagrams	2-14
2.2.6 Switching connectors	2-18
2.2.7 Setting the switches	2-23
2.2.8 Mounting and connecting the keypad to the panel	2-23
Chapter 3 NAMES AND FUNCTIONS OF KEYPAD COMPONENTS	3-1
Chapter 4 RUNNING THE MOTOR FOR A TEST	4-1
4.1 Checking Prior to Powering ON	4-1
4.2 Powering ON and Checking	4-1
4.3 Configuring the Function Code Data Before Test Run	4-2
4.4 Running the Inverter for Motor Operation Check ..	4-2
4.5 Preparation for Practical Operation	4-3
Chapter 5 TROUBLESHOOTING	5-1
5.1 Alarm Codes	5-1
Chapter 6 MAINTENANCE AND INSPECTION	6-1
6.1 Daily Inspection	6-1
6.2 Periodic Inspection	6-1
6.3 List of Periodic Replacement Parts	6-2
6.4 Inquiries about Product and Guarantee	6-3
6.4.1 When making an inquiry	6-3
6.4.2 Product warranty	6-3
Chapter 7 SPECIFICATIONS	7-1
7.1 Standard Model	7-1
7.2 External Dimensions	7-4
Chapter 8 CONFORMITY WITH STANDARDS	8-1
8.1 Compliance with European Standards	8-1
8.2 Conformity to the Low Voltage Directive in the EU	8-1
8.3 Compliance with EMC Standards	8-2
8.3.1 General	8-2
8.3.2 Recommended installation procedure	8-2
8.3.3 Leakage current of the EMC filter	8-3
8.4 Harmonic Component Regulation in the EU	8-5
8.4.1 General comments	8-5
8.4.2 Compliance with IEC/EN 61000-3-2	8-6
8.4.3 Compliance with IEC/EN 61000-3-12	8-6
8.5 Compliance with UL Standards and cUL-listed for Canada	8-6
8.5.1 General	8-6
8.5.2 Considerations when using FRENIC-AQUA in systems to be certified by UL and cUL-listed for Canada	8-6





Product Warranty

Free of charge warranty period and warranty range

Free of charge warranty period

- (1) The product warranty period is "1 year from the date of purchase" or 24 months from the manufacturing date imprinted on the name plate, whichever date is earlier.
- (2) However, in cases where the installation environment, conditions of use, frequency or use and times used, etc., have an effect on product life, this warranty period may not apply.
- (3) Furthermore, the warranty period for parts repaired by Fuji Electric's Service Department is "6 months from the date that repairs are completed."

Warranty range

- (1) In the event that breakdown occurs during the product's warranty period which is the responsibility of Fuji Electric, Fuji Electric will replace or repair the part of the product that has broken down free of charge at the place where the product was purchased or where it was delivered. However, if the following cases are applicable, the terms of this warranty may not apply.
 - ❶ The breakdown was caused by the installation conditions, environment, handling or methods of use, etc. which are not specified in the catalog, operation manual, specifications or other relevant documents.
 - ❷ The breakdown was caused by the product other than the purchased or delivered Fuji's product.
 - ❸ The breakdown was caused by the product other than Fuji's product, such as the customer's equipment or software design, etc.
 - ❹ Concerning the Fuji's programmable products, the breakdown was caused by a program other than a program supplied by this company, or the results from using such a program.
 - ❺ The breakdown was caused by modifications or repairs affected by a party other than Fuji Electric.
 - ❻ The breakdown was caused by improper maintenance or replacement of replaceable items, etc. specified in the operation manual or catalog, etc.
 - ❼ The breakdown was caused by a science or technical or other problem that was not foreseen when making practical application of the product at the time it was purchased or delivered.
 - ❽ The product was not used in the manner the product was originally intended to be used.
 - ❾ The breakdown was caused by a reason which Fuji Electric is not responsible, such as lightning or other disaster.
- (2) Furthermore, the warranty specified herein shall be limited to the purchased or delivered product alone.
- (3) The upper limit for the warranty range shall be as specified in item (1) above and any damages (damage to or loss of machinery or equipment, or lost profits from the same, etc.) consequent to or resulting from breakdown of the purchased or delivered product shall be excluded from coverage by this warranty.

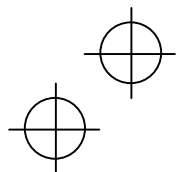
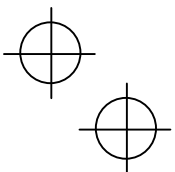

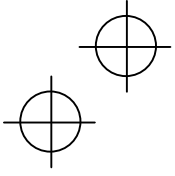

MEMO

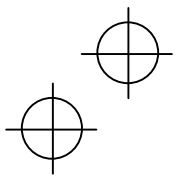
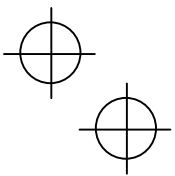
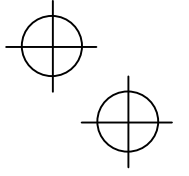

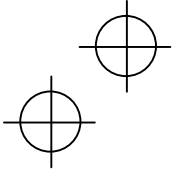

MEMO

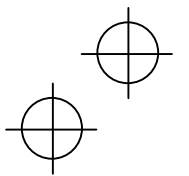
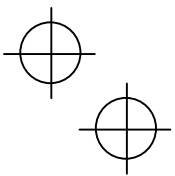
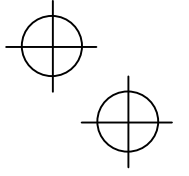

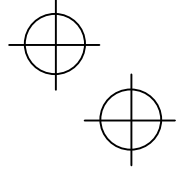
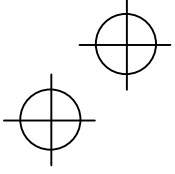

FRENIC-AQUA

Instruction Manual

First Edition, February 2012
4th Edition, November 2014

Fuji Electric Co., Ltd.

The purpose of this instruction manual is to provide accurate information in handling, setting up and operating of the FRENIC-AQUA series of inverters. Please feel free to send your comments regarding any errors or omissions you may have found, or any suggestions you may have for generally improving the manual.

In no event will Fuji Electric Co., Ltd. be liable for any direct or indirect damages resulting from the application of the information in this manual.

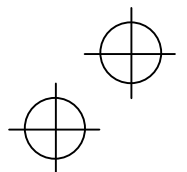
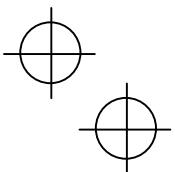

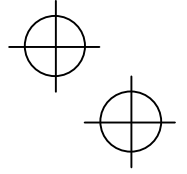
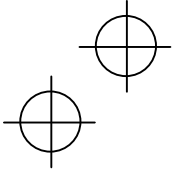

Fuji Electric Co., Ltd.

Gate City Ohsaki, East Tower, 11-2, Osaki 1-chome, Shinagawa-ku, Tokyo 141-0032, Japan

Phone: +81 3 5435 7058 Fax: +81 3 5435 7420

URL <http://www.fujielectric.com/>

